

3 Port Solenoid Valve

VQZ100/200/300 Series

Metal Seal

Rubber Seal



Power consumption: **0.35 w** / **0.9 w**
 (Standard) (High pressure type, High speed response type)

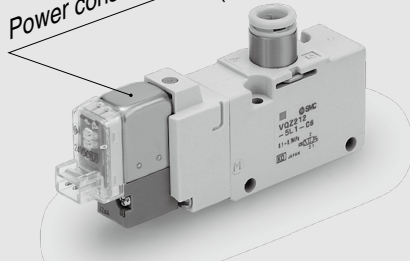

Compact, High Flow

	Series	Valve width (mm)	Flow rate characteristics	
			Metal seal C [dm ³ /(s·bar)]	Rubber seal C [dm ³ /(s·bar)]
Body ported	VQZ100	10	—	0.56 (Poppet)
	VQZ200	15	1.3	1.7
	VQZ300	18	2.4	3.0
Base mounted	VQZ100	10	—	1.0 (Poppet)
	VQZ200	15	2.0	3.0
	VQZ300	18	3.2	4.1

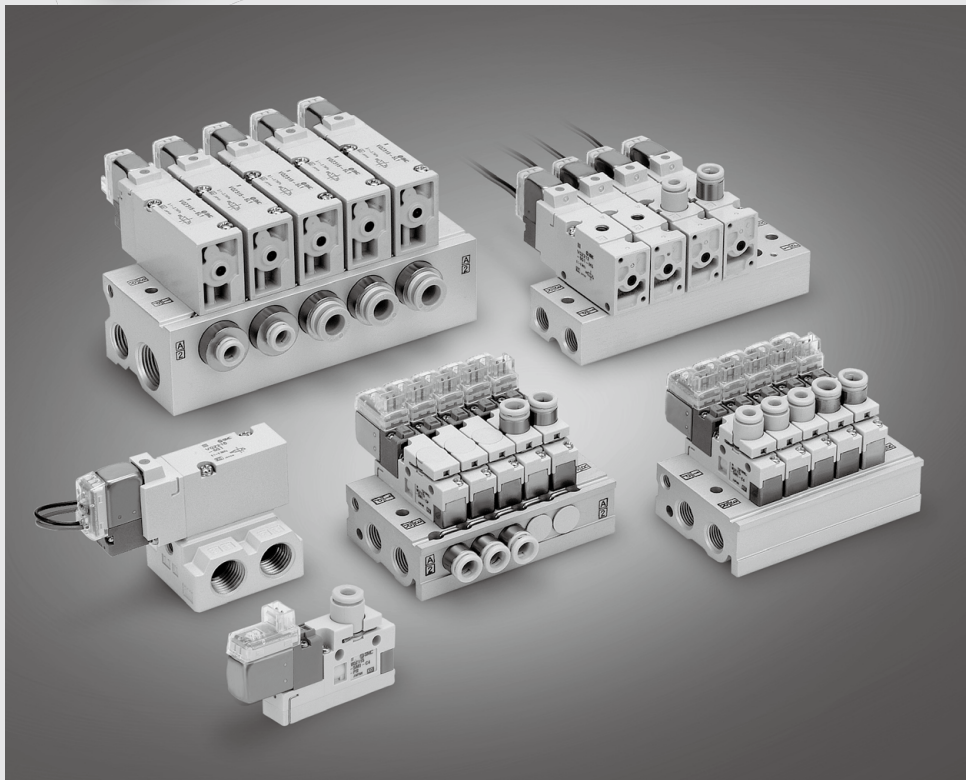













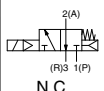

- SYJ
- VQZ**
- VP
- VG
- VP3

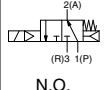
**Metal Seal / Rubber Seal
3 Port Solenoid Valve**

VQZ100/200/300

Solenoid Valve Variations

		Sonic conductance C [dm ³ /(s·bar)]		Type of actuation	Voltage	Electrical entry	Light/Surge voltage suppressor	Manual override
Body ported	3 port	VQZ100  P.1222	Metal — Rubber (Poppet) 0.56					
		VQZ200  P.1223	1.3 — 1.7			Grommet (G) 		
		VQZ300  P.1223	2.4 — 3.0	 N.C.	(Standard) 12 VDC 24 VDC	L-type plug connector (L)  M-type plug connector (M) 	With light/surge voltage suppressor	Non-locking push type (Tool required)
Base mounted	3 port	VQZ100  P.1238	Metal — Rubber (Poppet) 1.0	 N.O. (Except VQZ100)	(Option) 100 VAC 200 VAC 110 VAC 220 VAC	DIN terminal (Y)  DIN terminal (YZ)  (Except VQZ100)		Locking type (Tool required)
		VQZ200  P.1239	2.0 — 3.0			(Except VQZ100) 		
		VQZ300  P.1239	3.2 — 4.1					

VQZ100/200/300 Series

Manifold

Body Ported

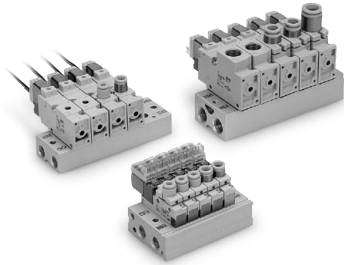

P.1229

Series	Base model	Piping direction	Piping specifications		Applicable solenoid valve	Applicable stations
			Bore size			
			1(P), 3(R)	2(A)		
VQZ100	VV3QZ12-□□□	Top	Rc 1/8	C3 (for ø3.2) C4 (for ø4) C6 (for ø6) M5 (M5 thread)	VQZ115	2 to 20 stations
VQZ200	VV3QZ22-□□□	Top	Rc 1/8	C4 (for ø4) C6 (for ø6) M5 (M5 thread)	VQZ2□2	2 to 20 stations
VQZ300	VV3QZ32-□□□	Top	Rc 1/4	C6 (for ø6) C8 (for ø8) C10 (for ø10) Rc 1/4	VQZ3□2	2 to 20 stations

Manifold Options

Body Ported

Blanking plate assembly
VVQZ100-10A-5
(for VQZ100)
VVQZ200-10A-2
(for VQZ200)
VVQZ300-10A-2
(for VQZ300)

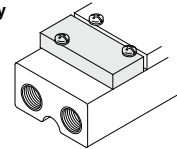

P.1235

Blanking plug
KQ2P-23
KQ2P-04
KQ2P-06
KQ2P-08
KQ2P-10

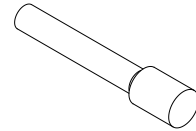

P.1235

DIN rail

AXT100-DR-□

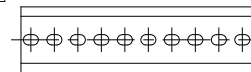

P.1235

Silencer
(for EXH port)

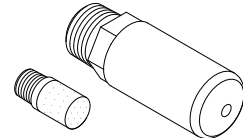

P.1235

Base Mounted

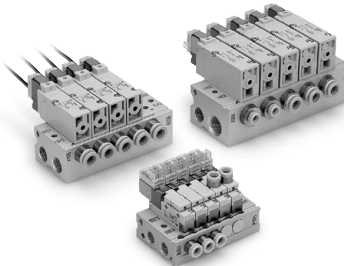

P.1245

Series	Base model	Piping direction	Piping specifications		Applicable solenoid valve	Applicable stations
			Bore size			
			1(P), 3(R)	2(A)		
VQZ100	VV3QZ15-□□□	Side/top	Rc 1/8	C3 (for ø3.2) C4 (for ø4) C6 (for ø6) M5 (M5 thread)	VQZ115	2 to 20 stations
VQZ200	VV3QZ25-□□□	Side	Rc 1/4	C4 (for ø4) C6 (for ø6) C8 (for ø8) Rc 1/8	VQZ2□5	2 to 20 stations
VQZ300	VV3QZ35-□□□	Side	1(P) port Rc 3/8 3(R) port Rc 1/4	C6 (for ø6) C8 (for ø8) C10 (for ø10) Rc 1/4	VQZ3□5	2 to 20 stations

Base Mounted

Blanking plate assembly
VVQZ100-10A-5
(for VQZ100)
VVQZ200-10A-5
(for VQZ200)
VVQZ300-10A-5
(for VQZ300)

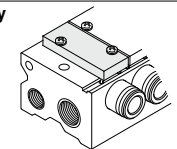

P.1252

Blanking plug
KQ2P-23
KQ2P-04
KQ2P-06
KQ2P-08
KQ2P-10

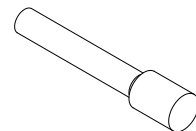

P.1252

DIN rail

AXT100-DR-□

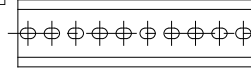

P.1252

Silencer
(for EXH port)

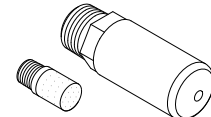

P.1252

Port plug
VVQZ100-CP (for VQZ100)



P.1252

SYJ

VQZ

VP

VG

VP3

Body Ported
Plug Lead Unit

3 Port Solenoid Valve

VQZ100/200/300 Series

Single Unit



[Option]
Note) CE-compliant:DC type only.

VQZ100 / How to Order Valve

VQZ 1 1 5 [] - 5 M [] 1 - C6 - PR [] - []

Series
1 VQZ100 body width 10 mm

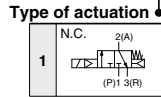

Body type

Function

Symbol	Specifications	DC	AC
Nil	Standard	(0.35 W) Note 3)	○
K Note 1)	High pressure type	(0.9 W)	—
R Note 1, 2)	External pilot type	○	○
KR Note 1, 2)	High pressure/External pilot type	(0.9 W)	—

Note 1) Semi-standard
Note 2) For details on external pilot type, refer to page 1236.
Note 3) For AC specification power consumption, refer to page 1224.

Caution
Use standard (DC) specification for continuous duty.

Coil voltage

		CE-compliant
1	100 VAC (50/60 Hz)	—
2	200 VAC (50/60 Hz)	—
3	110 VAC [115 VAC] (50/60 Hz)	—
4	220 VAC [230 VAC] (50/60 Hz)	—
5	24 VDC	●
6	12 VDC	●

CE-compliant

Nil	—
Q	CE-compliant

Note) DC type only.

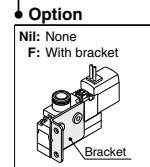

Port size [2(A) port]

C3	ø3.2 One-touch fitting
C4	ø4 One-touch fitting
C6	ø6 One-touch fitting
M5	M5 thread (Replaceable type)

Note) For inch size One-touch fittings, refer to page 1236.

Manual override

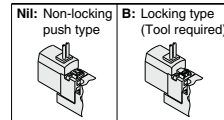

Electrical entry

G: Grommet (DC specification)	L: L-type plug connector with lead wire	LO: L-type plug connector without connector	M: M-type plug connector with lead wire	MO: M-type plug connector without connector
	With light/surge voltage suppressor	With light/surge voltage suppressor	With light/surge voltage suppressor	With light/surge voltage suppressor

Note) Standard lead wire length: 300 mm

Note) For applicable One-touch fitting and silencer models for this valve series, refer to page 1258.
Note) When placing an order for body ported solenoid valve as a single unit, mounting screw for manifold and gasket are not attached. Order them separately, if necessary. (For details, refer to page 1237.)

Body Ported VQZ100/200/300 Series

VQZ200/300 / How to Order Valve

Made to Order
(For details, refer to pages 1224 and 1255.)

Note) AC-type models that are CE-compliant have DIN terminals only.



VQZ **2** **1** **2** - **5** **M** - **1** - **C6** - -

Series

2	VQZ200 body width 15 mm
3	VQZ300 body width 18 mm

Type of actuation

	N.C. 2(A)	
1		Metal seal
2		Metal seal
3		Rubber seal
4		Rubber seal

Body type

2	Body ported
---	-------------

Function

Symbol	Specifications	DC (0.35 W) Note 3)	AC
Nil	Standard	<input type="radio"/>	<input type="radio"/>
B Note 1)	High speed response type	<input type="radio"/>	—
K Note 1)	High pressure type (Metal seal type only)	<input type="radio"/>	—
R Note 1, 2)	External pilot type	<input type="radio"/>	<input type="radio"/>
BR Note 1, 2)	High speed response/External pilot type	<input type="radio"/>	—
KR Note 1, 2)	High pressure/External pilot type (Metal seal type only)	<input type="radio"/>	—

Note 1) Semi-standard
Note 2) For details on external pilot type, refer to page 1236.
Note 3) For AC specification power consumption, refer to page 1224.

Caution
Use standard (DC) specification for continuous duty.

Coil voltage

1	100 VAC (50/60 Hz)
2	200 VAC (50/60 Hz)
3	110 VAC [115 VAC] (50/60 Hz)
4	220 VAC [230 VAC] (50/60 Hz)
5	24 VDC
6	12 VDC

Note) For applicable One-touch fitting and silencer models for this valve series, refer to back page 1258.
Note) When placing an order for body ported solenoid valve as a single unit, mounting screw for manifold and gasket are not attached. Order them separately, if necessary. (For details, refer to page 1237.)

CE-compliant

Nil	—
Q	CE-compliant

Note) AC-type models that are CE-compliant have DIN terminals only.

IP65 compliant

Nil	—
W Note)	Compliant

Note) VQZ200/300 DIN terminal rubber seal only (except external pilot). For details on IP65 enclosure, refer to page 1236.

Option

Nil: None
F: With bracket

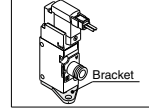

Port size [2(A) port]

Symbol	Port size	VQZ200	VQZ300
C4	ø4 One-touch fitting	<input type="radio"/>	—
C6	ø6 One-touch fitting	<input type="radio"/>	<input type="radio"/>
C8	ø8 One-touch fitting	<input type="radio"/>	<input type="radio"/>
C10	ø10 One-touch fitting	—	<input type="radio"/>
M5	M5 thread	<input type="radio"/>	—
O2	Rc 1/4	—	<input type="radio"/>

Note) For inch size One-touch fittings and option thread type, refer to page 1236.

Manual override

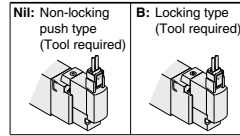

Electrical entry

	G: Grommet (DC specification)	L: L-type plug connector with lead wire	LO: L-type plug connector without connector	M: M-type plug connector with lead wire	MO: M-type plug connector without connector
	With light/surge voltage suppressor	With light/surge voltage suppressor	With light/surge voltage suppressor	With light/surge voltage suppressor	With light/surge voltage suppressor
CE-compliant	AC: — DC: ●	AC: — DC: ●	AC: — DC: ●	AC: — DC: ●	AC: — DC: ●
	Y: DIN terminal	YO: DIN terminal without connector	YZ: DIN terminal	YOS: DIN terminal without connector (DC specification)	YS: DIN terminal (DC specification)
	—	—	With light/surge voltage suppressor	With surge voltage suppressor	With surge voltage suppressor
CE-compliant	AC: ● DC: ●	AC: ● DC: ●	AC: ● DC: ●	AC: — DC: ●	AC: — DC: ●

Note 1) Standard lead wire length: 300 mm
Note 2) For AC voltage valves there is no "S" type. It is already built-in to the rectifier circuit.

SYJ
VQZ
VP
VG
VP3

VQZ100/200/300 Series

Construction

VQZ100 Poppet type

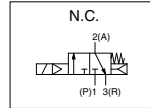
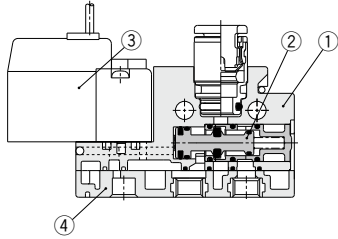

Component Parts

No.	Description	Material	Note
1	Body	Resin	
2	Spool valve	Aluminum/HNBR	
3	Pilot valve assembly	—	
4	P. R plate	Resin/Aluminum	VQZ100-12A (Standard) VQZ100-12B (External pilot type) ^{Note)}

Note) It is not possible to change the standard product to external pilot type, and vice versa.

VQZ200/300 Metal seal type

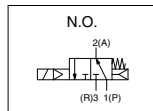
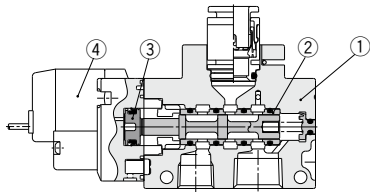
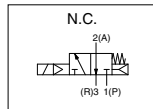
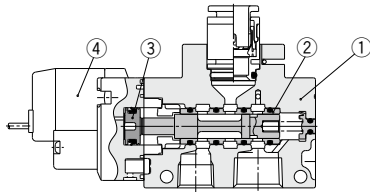

Rubber seal type

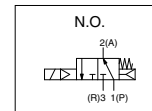
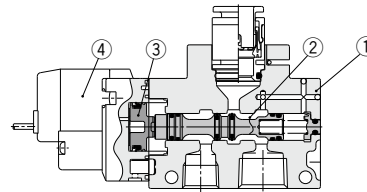
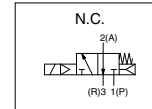
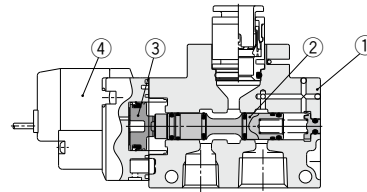

SYJ
VQZ
VP
VG
VP3

Component Parts

No.	Description	Material	Note
1	Body	Aluminum die-casted	
	Spool, Sleeve	Stainless steel	Metal seal
2	Spool valve	Aluminum/HNBR	Rubber seal
3	Piston	Resin	
4	Pilot valve assembly	—	

Note) For "How to Order Pilot Valve Assembly", refer to page 1237.

VQZ100/200/300 Series

Dimensions: VQZ100

Single Unit

Grommet (G): VQZ115□-□G□1-C3, C4, C6-PR

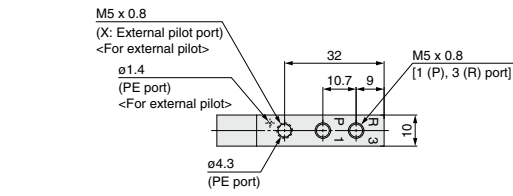
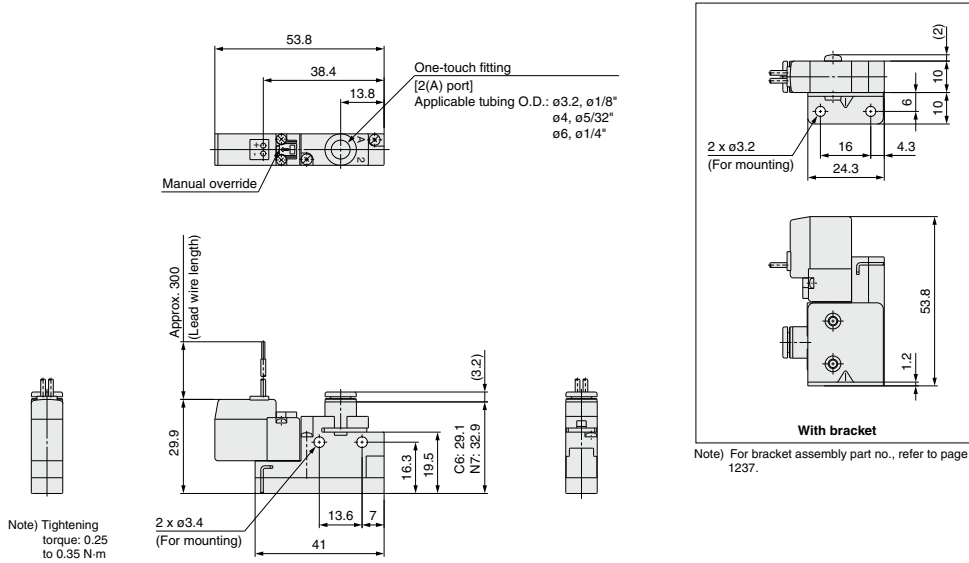

VQZ115□-□G□1-M5-PR

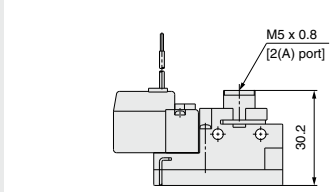

Note) For One-touch fittings for P/R port and silencer part no., refer to page 1258.

L-type plug connector (L): VQZ115□-□L□1-C3, C4, C6-PR

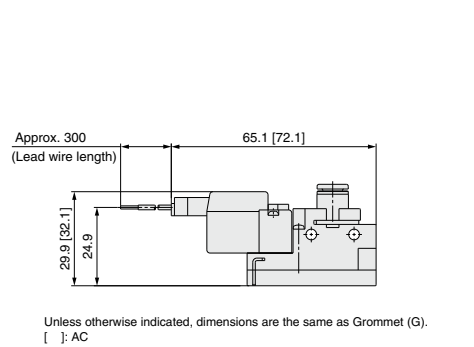

M-type plug connector (M): VQZ115□-□M□1-C3, C4, C6-PR

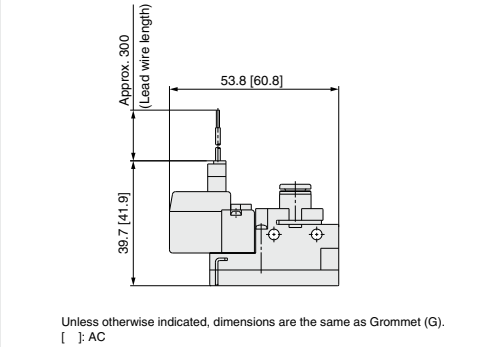

Body Ported **VQZ100/200/300 Series**

Dimensions: VQZ200

Single Unit

Grommet (G): VQZ2□2□-□G□1-C4, C6

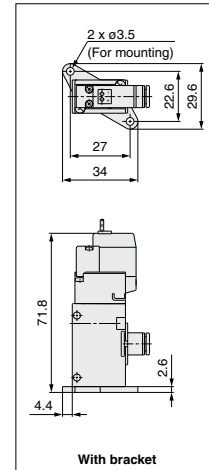
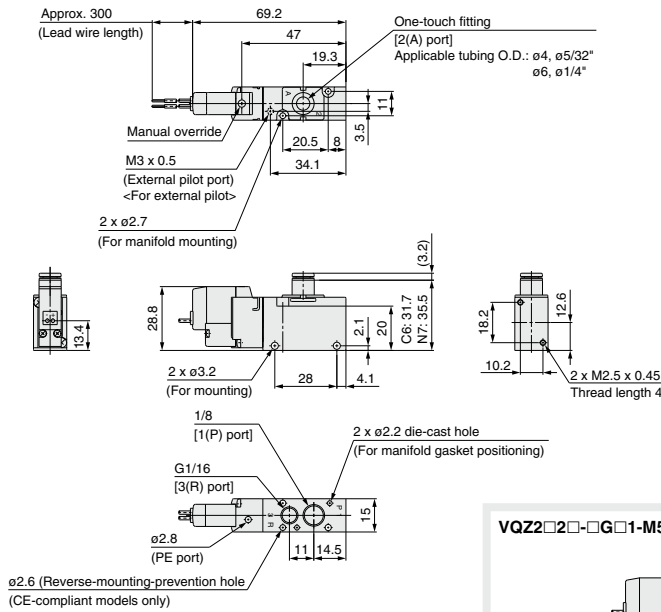

Note) For bracket assembly part no., refer to page 1237.

VQZ2□2□-□G□1-M5

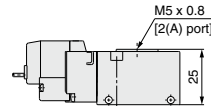

Note) For One-touch fittings for P/R port and silencer part no., refer to page 1258.

L-type plug connector (L): VQZ2□2□-□L□1-C4, C6

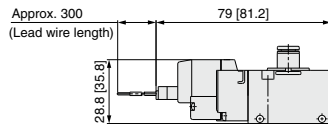

Unless otherwise indicated, dimensions are the same as Grommet (G).
[]: AC

M-type plug connector (M): VQZ2□2□-□M□1-C4, C6

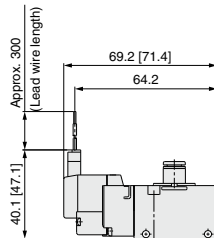

Unless otherwise indicated, dimensions are the same as Grommet (G).
[]: AC

DIN terminal (Y): VQZ2□2□-□Y□1-C4, C6

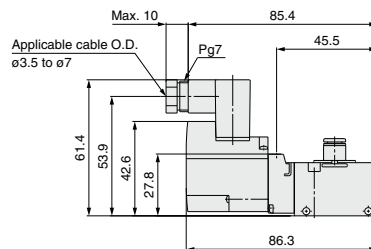

Unless otherwise indicated, dimensions are the same as Grommet (G).

SYJ

VQZ

VP

VG

VP3

VQZ100/200/300 Series

Dimensions: VQZ300

Single Unit

Grommet (G): VQZ3□2□-□G□1-C6, C8, C10

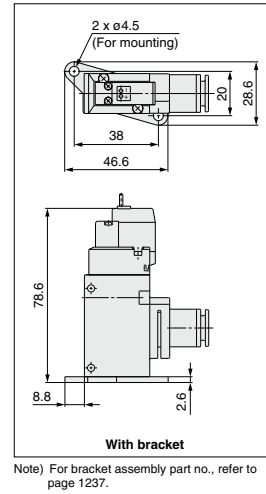
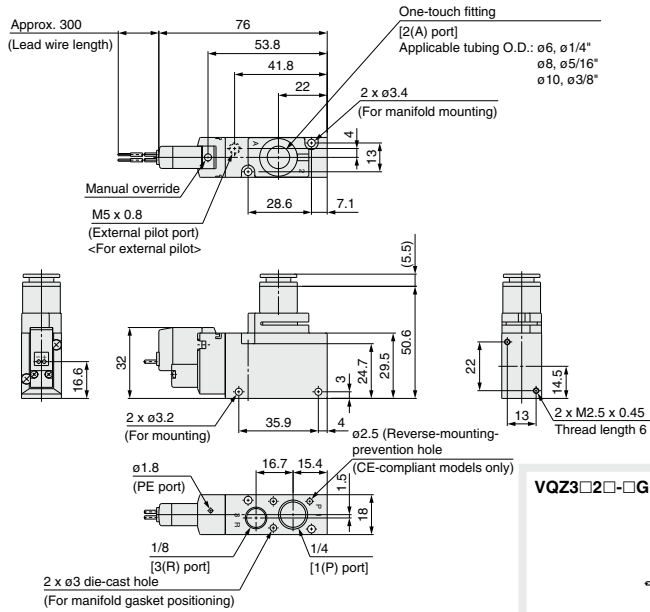

VQZ3□2□-□G□1-02

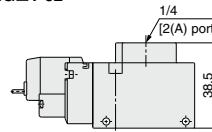

L-type plug connector (L): VQZ3□2□-□L□1-C6, C8, C10

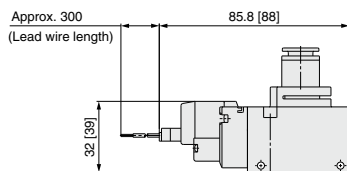

Unless otherwise indicated, dimensions are the same as Grommet (G).
[]: AC

DIN terminal (Y): VQZ3□2□-□Y□1-C6, C8, C10

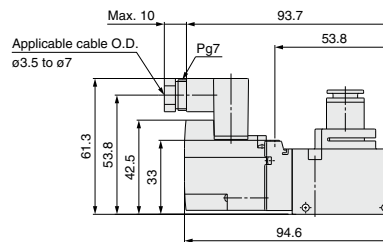

Unless otherwise indicated, dimensions are the same as Grommet (G).

M-type plug connector (M): VQZ3□2□-□M□1-C6, C8, C10

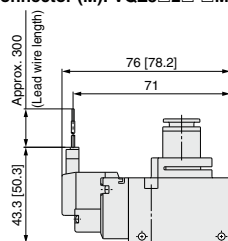

Unless otherwise indicated, dimensions are the same as Grommet (G).
[]: AC

Body Ported
Plug Lead Unit

3 Port Solenoid Valve VQZ100/200/300 Series Manifold Connector Kit



[Option]
Note) For CE-compliant models, DC type only.

VQZ100 / How to Order Manifold

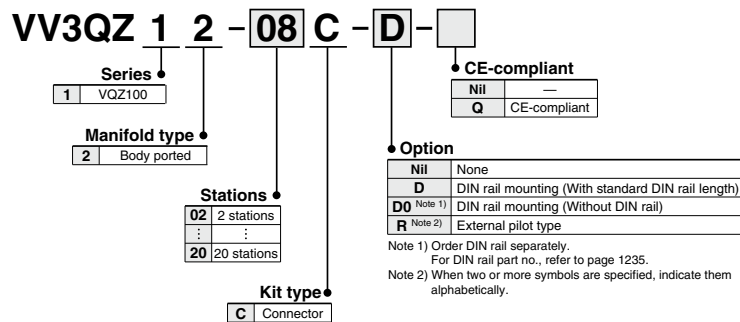

Note) For 1(P), 3(R) of optional thread type, refer to page 1236.

VQZ100 / How to Order Valve

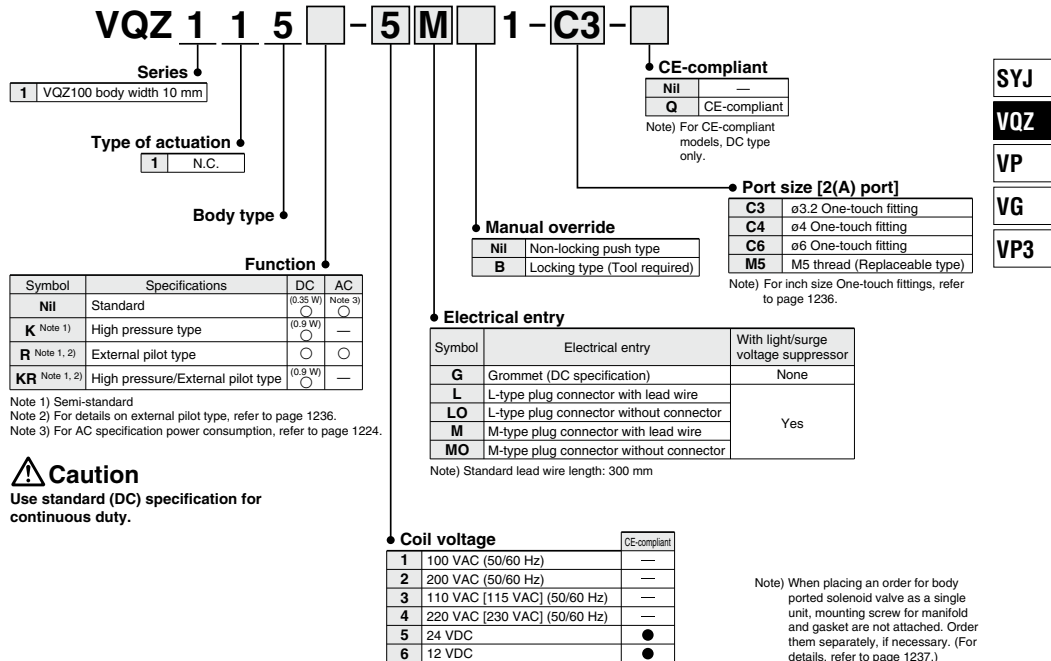

Caution
Use standard (DC) specification for continuous duty.

Note) When placing an order for body ported solenoid valve as a single unit, mounting screw for manifold and gasket are not attached. Order them separately, if necessary. (For details, refer to page 1237.)



VQZ100/200/300 Series

VQZ200/300 / How to Order Manifold



Made to Order
(For details, refer to page 1255.)

Note) AC-type models that are CE-compliant have DIN terminals only.



VV3QZ **2** **2** - **08** **C** - -

Series

2	VQZ200
3	VQZ300

Manifold type

2	Body ported
---	-------------

Stations

02	2 stations
...	...
20	20 stations

CE-compliant

Nil	—
Q	CE-compliant

Option

Nil	None
D	DIN rail mounting (With standard DIN rail length)
D0 ^{Note)}	DIN rail mounting (Without DIN rail)

Note) Order DIN rail separately.
For DIN rail part no., refer to page 1235.

Kit type

C	Connector
---	-----------

Note) For 1(P), 3(R) of optional thread type, refer to page 1236.

VQZ200/300 / How to Order Valve

VQZ **2** **1** **2** - **5** **M** - **1** - -

Series

2	VQZ200 body width 15 mm
3	VQZ300 body width 18 mm

Type of actuation

1	N.C. Metal seal
2	N.O. Metal seal
3	N.C. Rubber seal
4	N.O. Rubber seal

Body type

2	Body ported
---	-------------

Function

Symbol	Specifications	DC (0.3S W) ^{Note 3)}	AC
Nil	Standard	○	○
B ^{Note 1)}	High speed response type	○	—
K ^{Note 1)}	High pressure type (Metal seal type only)	○	—
R ^{Note 1, 2)}	External pilot type	○	○
BR ^{Note 1, 2)}	High speed response/External pilot type	○	—
KR ^{Note 1, 2)}	High pressure/External pilot type (Metal seal type only)	○	—

Note 1) Semi-standard
Note 2) For details on external pilot type, refer to page 1236.
Note 3) For AC specification power consumption, refer to page 1224.

Caution
Use standard (DC) specification for continuous duty.

Coil voltage

1	100 VAC (50/60 Hz)
2	200 VAC (50/60 Hz)
3	110 VAC [115 VAC] (50/60 Hz)
4	220 VAC [230 VAC] (50/60 Hz)
5	24 VDC
6	12 VDC

IP65 compliant

Nil	—
W ^{Note)}	Compliant

Note) VQZ200/300 DIN terminal rubber seal only (except external pilot). For details on IP65 enclosure, refer to page 1236.

CE-compliant

Nil	—
Q	CE-compliant

Note) AC-type models that are CE-compliant have DIN terminals only.

Port size [2(A) port]

Symbol	Port size	VQZ200	VQZ300
C4	ø4 One-touch fitting	○	—
C6	ø6 One-touch fitting	○	○
C8	ø8 One-touch fitting	—	○
C10	ø10 One-touch fitting	—	○
M5	M5 thread	○	—
O2	Rc 1/4	—	○

Note) For inch size One-touch fittings and optional thread type, refer to page 1236.

Manual override

Nil	Non-locking push type (Tool required)
B	Locking type (Tool required)

Electrical entry

Symbol	Electrical entry	Light/surge voltage suppressor	CE-compliant	
			AC	DC
G	Grommet (DC specification)	None	—	●
L	L-type plug connector with lead wire	Yes	—	●
LO	L-type plug connector without connector		—	●
M	M-type plug connector with lead wire		—	●
MO	M-type plug connector without connector		—	●
Y	DIN terminal	None	●	●
YO	DIN terminal without connector		●	●
YZ	DIN terminal		●	●
YS ^{Note 2)}	DIN terminal (DC specification)	Yes (Without light)	—	●
YOS ^{Note 2)}	DIN terminal without connector (DC specification)		—	●

Note 1) Standard lead wire length: 300 mm
Note 2) For AC voltage valves there is no "S" type. It is already built-in to the rectifier circuit.

Note) When placing an order for body ported solenoid valve as a single unit, mounting screw for manifold and gasket are not attached. Order them separately, if necessary. (For details, refer to page 1237.)

Body Ported **VQZ100/200/300 Series**

Manifold Specifications

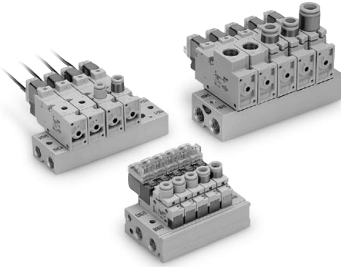

Series	Base model	Piping specifications			Applicable solenoid valve	Applicable stations	Manifold base weight (g)
		Piping direction	Port size				
			1(P), 3(R)	2(A)			
VQZ100	VV3QZ12-□□□	Top	Rc 1/8	C3 (for ø3.2) C4 (for ø4) C6 (for ø6) M5 (M5 thread)	VQZ115	2 to 20 stations	2 stations: 83 Addition per station: 19
VQZ200	VV3QZ22-□□□	Top	Rc 1/8	C4 (for ø4) C6 (for ø6) M5 (M5 thread)	VQZ2□2	2 to 20 stations	2 stations: 68 Addition per station: 20
VQZ300	VV3QZ32-□□□	Top	Rc 1/4	C6 (for ø6) C8 (for ø8) C10 (for ø10) Rc 1/4	VQZ3□2	2 to 20 stations	2 stations: 114 Addition per station: 37

How to Order Manifold Assembly (Example)

VV3QZ22-05C 1 set (C kit 5-station manifold base part no.)

* VVQZ200-10A-2 ... 1 set (Blanking plate assembly part no.)

* VQZ212-5M1-C6 ... 4 sets (N.C. type part no.)

→ The asterisk denotes the symbol for assembly. Prefix it to the part nos. of the solenoid valve, etc.

→ Enter in order starting from the first station on the D side.

Add the valve and option part number under the manifold base part number.
When entry of part numbers becomes complicated, indicate by the manifold specification sheet.

SYJ

VQZ

VP

VG

VP3

VQZ100/200/300 Series

Dimensions: VQZ100

VV3QZ12-[Stations] C

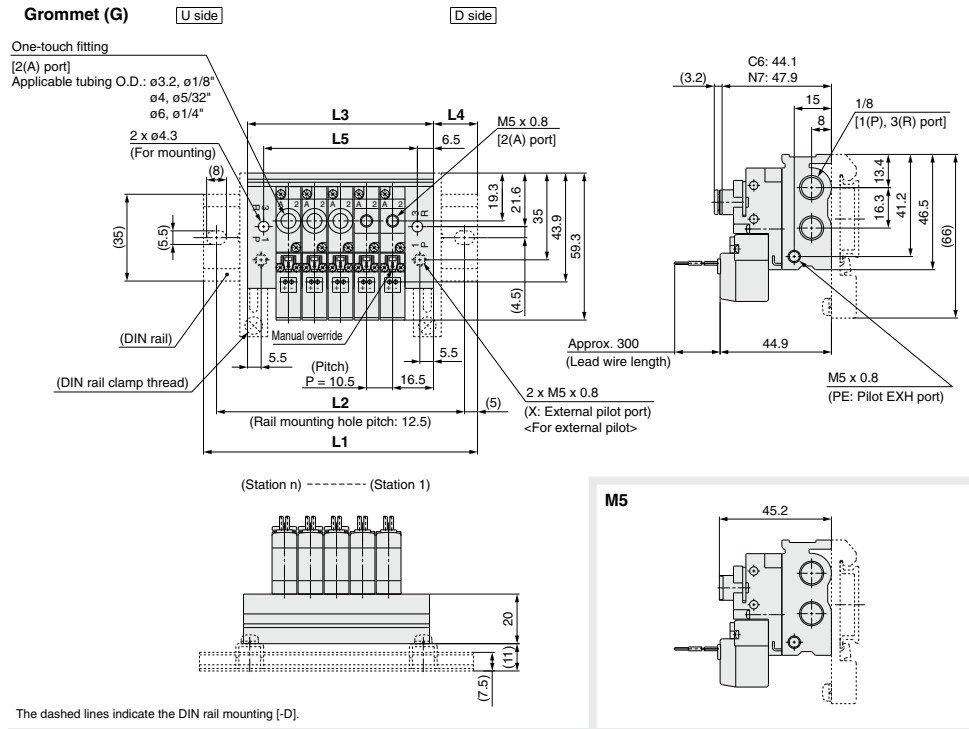

L-type plug connector (L)

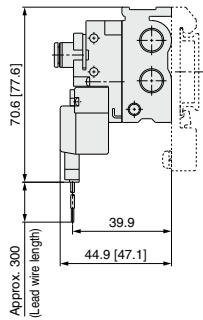

Unless otherwise indicated, dimensions are the same as Grommet (G).
[] : AC

M-type plug connector (M)

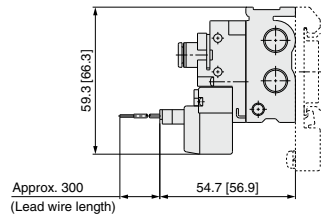

Unless otherwise indicated, dimensions are the same as Grommet (G).
[] : AC

Dimensions

L	n: Stations (Max. 20 stations)																			
	2	3	4	5	6	7	8	9	10	11	12	13	14	15	16	17	18	19	20	
L1	85.5	85.5	98	110.5	123	135.5	148	148	160.5	173	185.5	198	210.5	210.5	223	235.5	248	260.5	273	
L2	75	75	87.5	100	112.5	125	137.5	137.5	150	162.5	175	187.5	200	200	212.5	225	237.5	250	262.5	
L3	43.5	54	64.5	75	85.5	96	106.5	117	127.5	138	148.5	159	169.5	180	190.5	201	211.5	222	232.5	
L4	21	16	17	18	19	20	21	15.5	16.5	17.5	18.5	19.5	20.5	15.5	16.5	17.5	18.5	19.5	20.5	
L5	30.5	41	51.5	62	72.5	83	93.5	104	114.5	125	135.5	146	156.5	167	177.5	188	198.5	209	219.5	

VQZ100/200/300 Series

Dimensions: VQZ300

VV3QZ32-[Stations] C

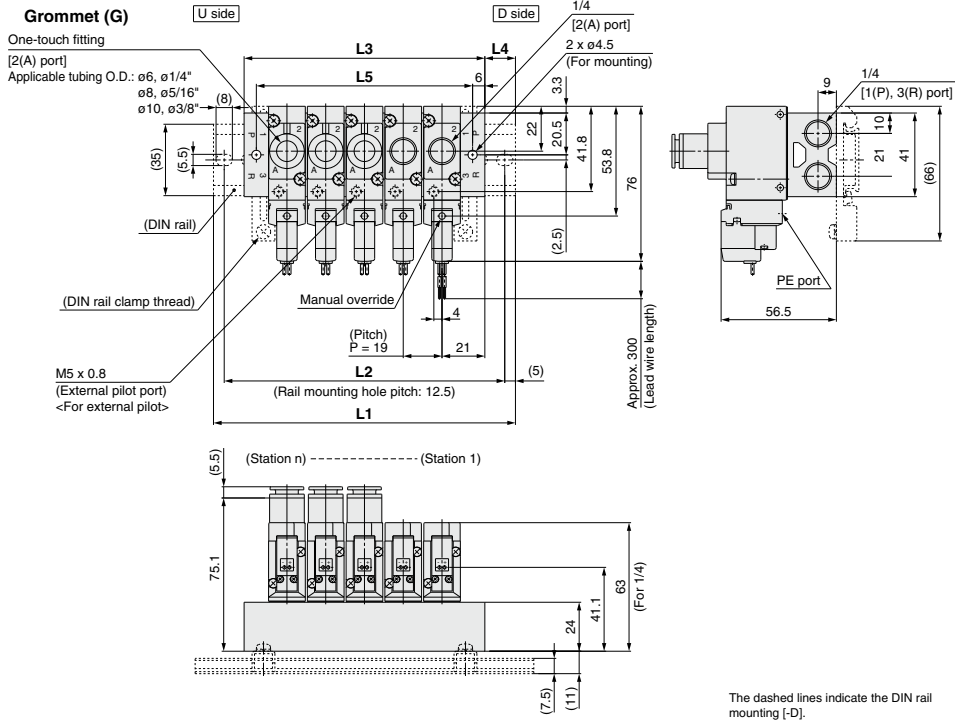

L-type plug connector (L)

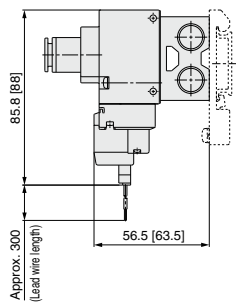

Unless otherwise indicated, dimensions are the same as Grommet (G).
 []: AC

M-type plug connector (M)

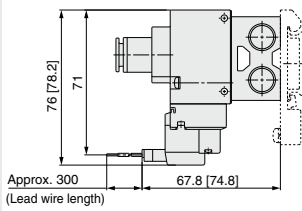

Unless otherwise indicated, dimensions are the same as Grommet (G).
 []: AC

DIN terminal (Y)

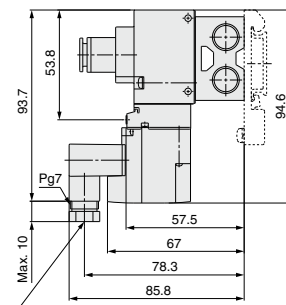

Unless otherwise indicated, dimensions are the same as Grommet (G).

Dimensions

L	n: Stations (Max. 20 stations)																			
	2	3	4	5	6	7	8	9	10	11	12	13	14	15	16	17	18	19	20	
L1	98	110.5	135.5	148	173	198	210.5	235.5	248	273	285.5	310.5	323	348	360.5	385.5	398	423	435.5	
L2	87.5	100	125	137.5	162.5	187.5	200	225	237.5	262.5	275	300	312.5	337.5	350	375	387.5	412.5	425	
L3	61	80	99	118	137	156	175	194	213	232	251	270	289	308	327	346	365	384	403	
L4	18.5	15.5	18.5	15	18	21	18	21	17.5	20.5	17.5	20.5	17	20	17	20	16.5	19.5	16.5	
L5	49	68	87	106	125	144	163	182	201	220	239	258	277	296	315	334	353	372	391	

Body Ported **VQZ100/200/300 Series**

Manifold Options

Blanking plate assembly

VVQZ100-10A-5 (for VQZ100)

VVQZ200-10A-2 (for VQZ200)

VVQZ300-10A-2 (for VQZ300)

It is used by attaching on the manifold block for being prepared for removing a valve for maintenance reasons or planning to mount a spare valve, etc.

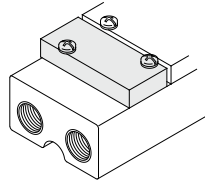

Blanking plug

KQ2P-23

KQ2P-04

KQ2P-06

KQ2P-08

KQ2P-10

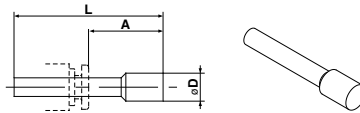

Dimensions

(mm)

Applicable fitting size ød	Model	A	L	D
3.2	KQ2P-23	16	31.5	5
4	KQ2P-04	16	32	6
6	KQ2P-06	18	35	8
8	KQ2P-08	20.5	39	10
10	KQ2P-10	22	43	12

DIN rail

AXT100-DR-□

* As for □, enter the number from the DIN rail dimensions table.
For L dimension, refer to the dimensions of each kit.

Each manifold can be mounted on a DIN rail.

Insert "D" at the end of the manifold part number.

The DIN rail is approximately 30 mm longer than the length of manifold.

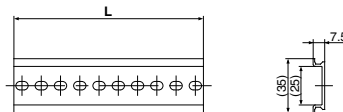

L Dimension

No.	1	2	3	4	5	6	7	8	9	10	11	12	13	14	15	16	17	18	19	20
L dimension	23	35.5	48	60.5	73	85.5	98	110.5	123	135.5	148	160.5	173	185.5	198	210.5	223	235.5	248	260.5
No.	21	22	23	24	25	26	27	28	29	30	31	32	33	34	35	36	37	38	39	40
L dimension	273	285.5	298	310.5	323	335.5	348	360.5	373	385.5	398	410.5	423	435.5	448	460.5	473	485.5	498	510.5

SYJ

VQZ

VP

VG

VP3

Silencer

(for manifold EXH port)

Silencer is installed in the manifold EXH port.

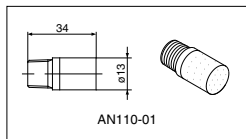

AN110-01

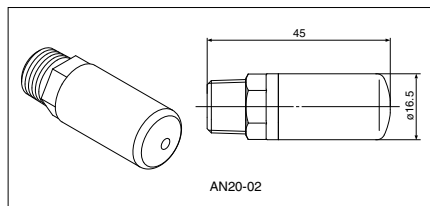

AN20-02

Dimensions

Model	Silencer part no.
VQZ100	AN110-01
VQZ200	AN110-01
VQZ300	AN20-02

For a silencer to be mounted in a single valve unit, refer to page 1258.

VQZ Series Body Ported

Replacement Parts

One-touch Fitting Assembly (for Cylinder port)

Model	Fitting size	C3	C4	C6	C8	C10	M5 (VQZ100 only)
VQZ100/200		VVQ1000-50A-C3	VVQ1000-50A-C4	VVQ1000-50A-C6	—	—	VVQ1000-50A-M5
VQZ300		—	—	VVQ1000-51A-C6	VVQ1000-51A-C8	VVQ1000-51A-C10	—

Note) Purchasing order is available in units of 10 pieces.

<Plug connector assembly>

- DC: SY100-30-4A-□
- 100 VAC: SY100-30-1A-□
- 200 VAC: SY100-30-2A-□
- Other AC voltages: SY100-30-3A-□

Without lead wire: SY100-30-A
(with connector and 2 sockets only)

Lead wire length

Symbol	Length
Nil	300 mm
6	600 mm
10	1000 mm
15	1500 mm
20	2000 mm
25	2500 mm
30	3000 mm
50	5000 mm

How to Order

Include the connector assembly part number together with the part number for the plug connector's solenoid valve without connector.

Example) In case of 2000 mm of lead wire

DC	AC
VQZ115-5LO1-M5-PR	VQZ115-1LO1-M5-PR
SY100-30-4A-20	SY100-30-1A-20

<Gasket and screw assembly>

Model	Part no.
VQZ100	VQZ100-GS-5
VQZ200	VQZ200-GS-2
VQZ300	VQZ300-GS-2

Note 1) The above part numbers are for 10 valves (a set of 10 gaskets and 20 screws).

Note 2) VQZ100 is common to the body ported type and base mounted type.

<Bracket assembly>

Model	Part no.	Tightening torque (N·m) ^{Note)}
VQZ100	VQZ100-FB	0.25 to 0.35
VQZ200	VQZ200-FB	
VQZ300	VQZ300-FB	

Note) Tightening torque when mounting a bracket on the valve.

<Pilot valve assembly>

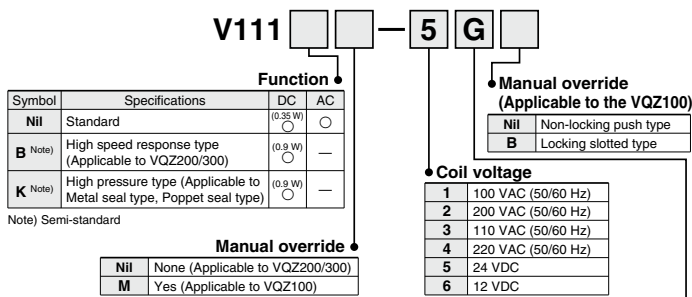

Symbol	DC	AC	Electrical entry	Light/surge voltage suppressor
G	—	—	Grommet (DC specification)	None
LU	—	—	L-type plug connector with lead wire	Yes
LOU	—	—	L-type plug connector without connector	
MU	—	—	M-type plug connector with lead wire	
MOU	—	—	M-type plug connector without connector	

Note) VQZ pilot valve electrical entry (L, M) is the opposite of the how to order of valve body.

Valve model	Pilot valve model
VQZ115□□□□□□□□	V111□□□□□□□□
VQZ115□□□□□□□□	V111□□□□□□□□

<DIN terminal type (Applicable to the VQZ200/300)>

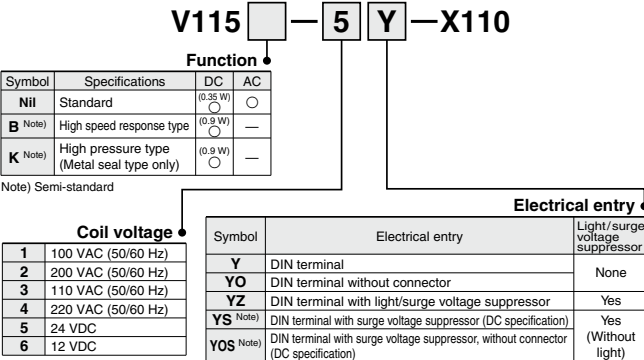

Note) For AC voltage valves there is no "S" type. It is already built-in to the rectifier circuit.

⚠ Caution

When replacing only the pilot valve assembly, use caution because it is not possible to convert to a V115 (DIN terminal) from a V111 (Grommet, L-type, M-type), or vice versa.

Base Mounted
Plug Lead Unit

3 Port Solenoid Valve

VQZ100/200/300 Series

Single Unit



[Option]
Note) For CE-compliant models, DC type only.

VQZ100 / How to Order Valve

VQZ 1 1 5 - **5 M** 1 - **01** -

Series

1	VQZ100 body width 10 mm
----------	-------------------------

Type of actuation

Body type

5	Base mounted
----------	--------------

Function

Symbol	Specifications	DC (0.35 W) Note 3)	AC
Nil	Standard	○	○
K Note 1)	High pressure type	○	—
R Note 1, 2)	External pilot type	○	○
KR Note 1, 2)	High pressure/External pilot type	○	—

Note 1) Semi-standard
Note 2) For details on external pilot type, refer to page 1253.
Note 3) For AC specification power consumption, refer to page 1240.

Caution
Use standard (DC) specification for continuous duty.

CE-compliant

Nil	—
Q	CE-compliant

Note) For CE-compliant models, DC type only.

Port size

CP	Without sub-plate
01	Rc 1/8

Note) For optional thread type, refer to page 1253.

Manual override

Nil : Non-locking push type	B : Locking type (Tool required)
------------------------------------	---

Electrical entry

G: Grommet (DC specification)	L: L-type plug connector with lead wire	LO: L-type plug connector without connector	M: M-type plug connector with lead wire	MO: M-type plug connector without connector
With light/surge voltage suppressor	With light/surge voltage suppressor	With light/surge voltage suppressor	With light/surge voltage suppressor	With light/surge voltage suppressor

Note) Standard lead wire length: 300 mm

Coil voltage

	CE-compliant
1 100 VAC (50/60 Hz)	—
2 200 VAC (50/60 Hz)	—
3 110 VAC [115 VAC] (50/60 Hz)	—
4 220 VAC [230 VAC] (50/60 Hz)	—
5 24 VDC	●
6 12 VDC	●

Note) For sub-plate part no., refer to page 1254.
Note) When ordering single unit of the base mounted type solenoid valve, the mounting screws and gaskets for the manifold are included.

Base Mounted VQZ100/200/300 Series

VQZ200/300 / How to Order Valve



Made to Order
(For details, refer to pages 1240 and 1255.)

Note) AC-type models that are CE-compliant have DIN terminals only.



VQZ **2** **1** **5** - **5** **M** **1** -

Series

2	VQZ200 body width 15 mm
3	VQZ300 body width 18 mm

Type of actuation

Actuation	Seal
1 N.C. 2(A) (R)S 1(P)	Metal seal
2 N.O. 2(A) (R)S 1(P)	Metal seal
3 N.C. 2(A) (R)S 1(P)	Rubber seal
4 N.O. 2(A) (R)S 1(P)	Rubber seal

Body type

5	Body mounted
---	--------------

Function

Symbol	Specifications	DC	AC
Nil	Standard	(0.35 W) <small>Note 3)</small>	○
B <small>Note 1)</small>	High speed response type	(0.9 W) ○	—
K <small>Note 1)</small>	High pressure type (Metal seal type only)	(0.9 W) ○	—
R <small>Note 1, 2)</small>	External pilot type	○	○
BR <small>Note 1, 2)</small>	High speed response/External pilot type	(0.9 W) ○	—
KR <small>Note 1, 2)</small>	High pressure/External pilot type (Metal seal type only)	(0.9 W) ○	—

Note 1) Semi-standard
Note 2) For details on external pilot type, refer to page 1253.
Note 3) For AC specification power consumption, refer to page 1240.

Caution
Use standard (DC) specification for continuous duty.

IP65 compliant

Nil	—
W <small>Note)</small>	Compliant

Note) VQZ200/300 DIN terminal rubber seal only (except external pilot). For details on IP65 enclosure, refer to page 1253.

CE-compliant

Nil	—
Q	CE-compliant

Note) AC-type models that are CE-compliant have DIN terminals only.

Port size

Symbol	Port size	VQZ200	VQZ300
Nil	Without sub-plate	○	○
01	Rc 1/8	○	—
02	Rc 1/4	○	○
03	Rc 3/8	—	○

Note) For optional thread type, refer to page 1253.

Manual override

Nil : Non-locking push type (Tool required)	B : Locking type (Tool required)
--	---

Electrical entry

	G: Grommet (DC specification)	L: L-type plug connector with lead wire	LO: L-type plug connector without connector	M: M-type plug connector with lead wire	MO: M-type plug connector without connector
	With light/surge voltage suppressor	With light/surge voltage suppressor	With light/surge voltage suppressor	With light/surge voltage suppressor	With light/surge voltage suppressor
CE- mark	—	—	—	—	—
AC	●	●	●	●	●
DC	●	●	●	●	●
	Y : DIN terminal	YO : DIN terminal without connector	YZ : DIN terminal	YOS : DIN terminal without connector (DC specification)	YS : DIN terminal (DC specification)
	With light/surge voltage suppressor	With light/surge voltage suppressor	With light/surge voltage suppressor	With surge voltage suppressor	With surge voltage suppressor
CE- mark	●	●	●	—	—
AC	●	●	●	●	●
DC	●	●	●	●	●

Note 1) Standard lead wire length: 300 mm
Note 2) For AC voltage valves there is no "S" type. It is already built-in to the rectifier circuit.

Coil voltage

1	100 VAC (50/60 Hz)
2	200 VAC (50/60 Hz)
3	110 VAC [115 VAC] (50/60 Hz)
4	220 VAC [230 VAC] (50/60 Hz)
5	24 VDC
6	12 VDC

Note) For sub-plate part no., refer to page 1254.
Note) When ordering single unit of the base mounted type solenoid valve, the mounting screws and gaskets for the manifold are included.

SYJ
VQZ
VP
VG
VP3



VQZ100/200/300 Series

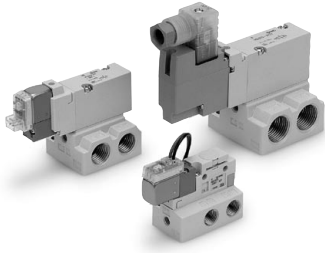

Specifications

Valve construction	Metal seal	Rubber seal	VQZ100 (Poppet seal)
Fluid	Air		
Max. operating pressure (MPa)	0.7 (High pressure type: 1.0)	0.7	0.7 (High pressure type: 1.0)
Min. operating pressure (MPa)	0.1	0.15	0.15
Ambient and fluid temperature (°C)	-10 to 50 (No freezing)		
Max. operating frequency (Hz)	20	5	20
Pilot exhaust method	Individual exhaust		Common exhaust
Lubrication	Not required		
Manual override	Push type, Locking type (Tool required)		
Mounting orientation	Free		
Impact/Vibration resistance (m/s ²) ^{Note 1)}	150/30		
Enclosure*	Dustproof (DIN terminal: IP65 ^{Note 2)})		

* Based on IEC60529

Note 1) Impact resistance: No malfunction occurred when it is tested with a drop tester in the axial direction and at the right angles to the main valve and armature in both energized and de-energized states every once for each condition. (Value in the initial state)

Vibration resistance: No malfunction occurred in one sweep test between 45 and 2000 Hz. Test was performed to axis and right angle directions of the main valve and armature when pilot signal is ON and OFF. (Value in the initial state)

Note 2) When IP65 compliant DIN terminals are selected: VQZ□□5□□□□W1□□□

Solenoid Specifications

Electrical entry	Grommet (G)		M-type plug connector (M)	
	L-type plug connector (L)		DIN terminal (Y)	
	G, L, M		Y	
Coil rated voltage (V)	DC	24, 12		
	AC 50/60 Hz	100, 110, 200, 220*		
Allowable voltage fluctuation	±10% of rated voltage*			
Power consumption (W)	DC	Standard	0.35 [(With light: 0.4 (DIN terminal with light: 0.45)]	
		High speed response, high pressure	0.9 [(With light: 0.95 (DIN terminal with light: 1.0)]	
Apparent power (VA)	AC	100 V	0.78 (With light: 0.81)	0.78 (With light: 0.87)
		110 V [115 V]	0.86 (With light: 0.89) [0.94 (With light: 0.97)]	0.86 (With light: 0.87) [0.94 (With light: 1.07)]
		200 V	1.18 (With light: 1.22)	1.15 (With light: 1.30)
		220 V	1.30 (With light: 1.34)	1.27 (With light: 1.46)
		230 V	1.42 (With light: 1.46)]	1.39 (With light: 1.60)]
Surge voltage suppressor	Varistor			
Indicator light	LED (Neon light when AC with DIN terminal)			

* In common between 110 VAC and 115 VAC, and between 220 VAC and 230 VAC.

* For 115 VAC and 230 VAC, the allowable voltage is -15% to +5% of rated voltage.

Semi-standard Specifications

High speed response type
High pressure type (Metal seal type only)
External pilot type*

* For details on external pilot type, refer to page 1253.



Made to Order
(For details, refer to page 1255.)

Symbol	Description
X30	Pilot valve common exhaust
X90	Main valve fluororubber
X113	All fluororubber

Flow Rate Characteristics

Series	Valve construction	Model	Flow rate characteristics						Response time (ms) ^{Note 1)}				Weight (g) ^{Note 2)}	
			1 → 2 (P → A)			2 → 3 (A → R)			Standard: 0.35 W	High speed response: 0.9 W	High pressure: 0.9 W	AC		
			C [dm ³ /(s·bar)]	b	Cv	C [dm ³ /(s·bar)]	b	Cv						
VQZ100	N.C. valve	Poppet	VQZ115	0.87	0.46	0.23	1.0	0.35	0.25	10 or less	—	13 or less	22 or less	24
VQZ200	N.C. valve	Metal seal	VQZ215	1.7	0.17	0.38	2.0	0.20	0.45	22 or less	14 or less	18 or less	34 or less	52
		Rubber seal	VQZ235	2.3	0.46	0.65	3.0	0.40	0.80	22 or less	15 or less	—	36 or less	
	N.O. valve	Metal seal	VQZ225	1.7	0.18	0.38	1.8	0.21	0.39	22 or less	14 or less	18 or less	34 or less	
		Rubber seal	VQZ245	2.5	0.43	0.67	3.0	0.30	0.74	22 or less	15 or less	—	36 or less	
VQZ300	N.C. valve	Metal seal	VQZ315	3.0	0.21	0.70	3.2	0.27	0.80	22 or less	17 or less	22 or less	34 or less	78
		Rubber seal	VQZ335	4.5	0.42	1.3	4.1	0.36	1.0	33 or less	25 or less	—	57 or less	
	N.O. valve	Metal seal	VQZ325	2.9	0.21	0.72	2.9	0.16	0.69	22 or less	17 or less	22 or less	34 or less	
		Rubber seal	VQZ345	4.4	0.45	1.2	4.5	0.38	1.2	33 or less	25 or less	—	57 or less	

Note 1) Based on JIS B 8374-1981 (Supply pressure: 0.5 MPa; with light/surge voltage suppressor: clean air)

Response time values will change depending on pressure and air quality.

Note 2) Weight without sub-plate.

Base Mounted **VQZ100/200/300 Series**

Construction

VQZ100 Poppet type

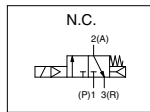
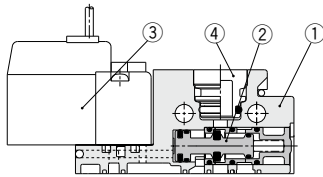

Component Parts

No.	Description	Material	Note
1	Body	Resin	
2	Spool valve	Aluminum/HNBR	
3	Pilot valve assembly	—	
4	Port plug	Resin/HNBR	VVQZ100-CP

VQZ200/300 Metal seal type

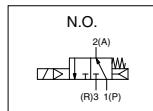
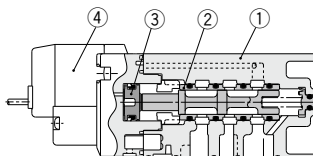
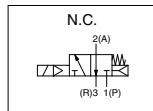
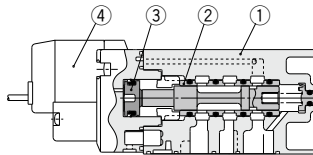

Rubber seal type

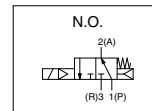
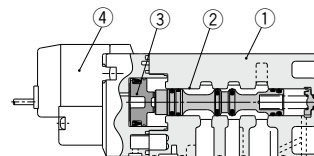
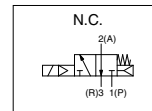
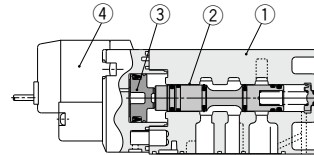

SYJ
VQZ
VP
VG
VP3

Component Parts

No.	Description	Material	Note
1	Body	Aluminum die-casted	
2	Spool, Sleeve	Stainless steel	Metal seal
2	Spool valve	Aluminum/HNBR	Rubber seal
3	Piston	Resin	
4	Pilot valve assembly	—	

Note) For "How to Order Pilot Valve Assembly", refer to page 1254.

VQZ100/200/300 Series

Dimensions: VQZ100

Single Unit

Grommet (G): VQZ115□-□G□1-01

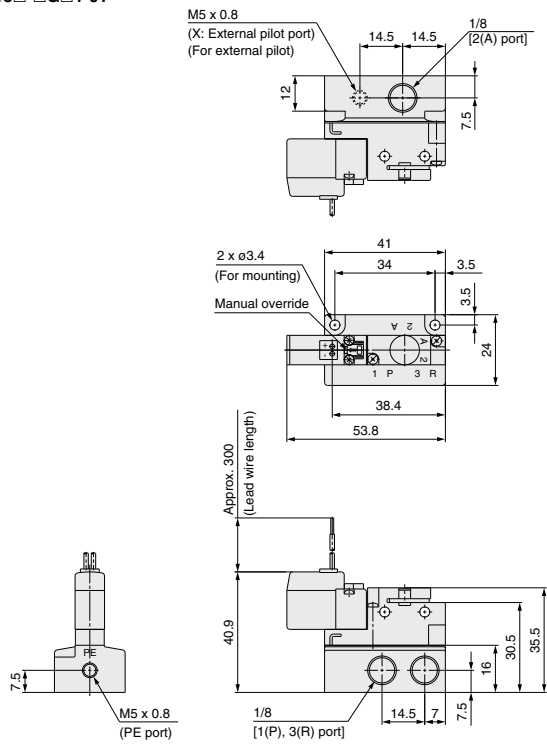

L-type plug connector (L): VQZ115□-□L□1-01

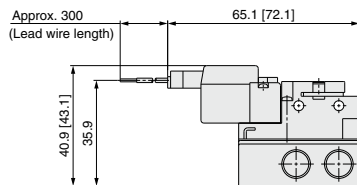

M-type plug connector (M): VQZ115□-□M□1-01

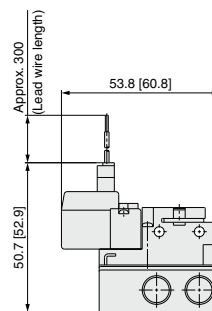

Unless otherwise indicated, dimensions are the same as Grommet (G).
[]: AC

1242

Unless otherwise indicated, dimensions are the same as Grommet (G).
[]: AC

Base Mounted **VQZ100/200/300 Series**

Dimensions: **VQZ200**

Single Unit

Grommet (G): **VQZ2□5□-□G□1-⁰¹₀₂**

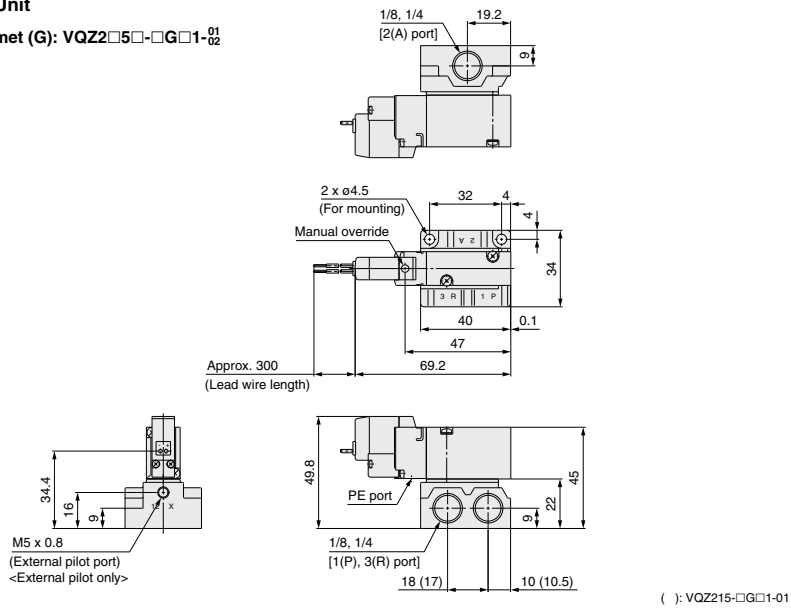

L-type plug connector (L): VQZ2□5□-□L□1-⁰¹₀₂

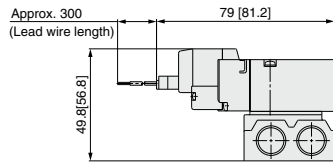

Unless otherwise indicated, dimensions are the same as Grommet (G).
[] : AC

M-type plug connector (M): VQZ2□5□-□M□1-⁰¹₀₂

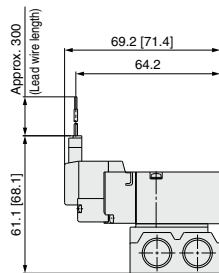

Unless otherwise indicated, dimensions are the same as Grommet (G).
[] : AC

DIN terminal (Y): VQZ2□5□-□Y□1-⁰¹₀₂

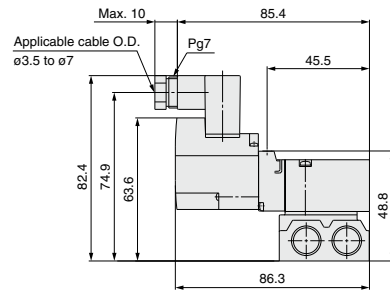

Unless otherwise indicated, dimensions are the same as Grommet (G).
[] : AC

SYJ

VQZ

VP

VG

VP3

VQZ100/200/300 Series

Dimensions: VQZ300

Single Unit

Grommet (G): VQZ3□5□-□G□1-02⁰³

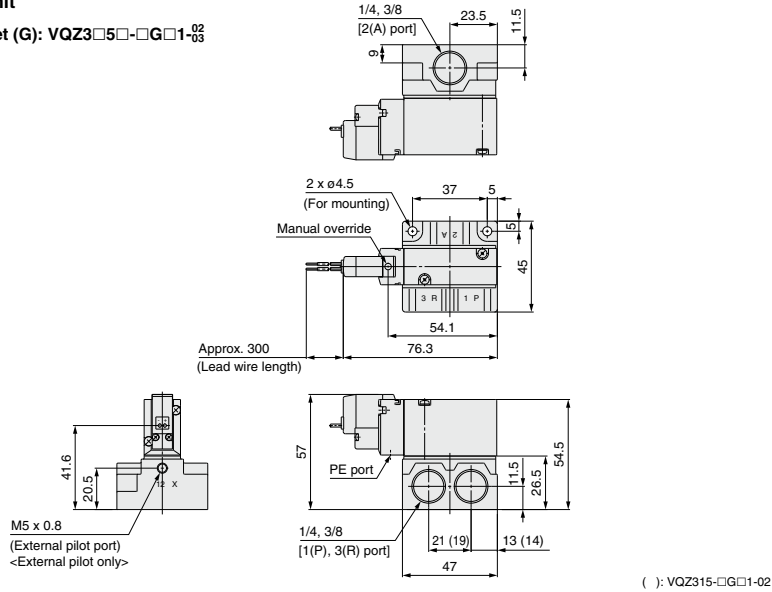

L-type plug connector (L): VQZ3□5□-□L□1-02⁰³

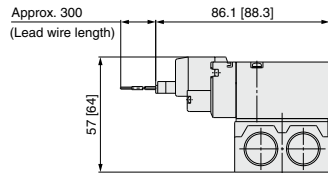

Unless otherwise indicated, dimensions are the same as Grommet (G).
[] : AC

M-type plug connector (M): VQZ3□5□-□M□1-02⁰³

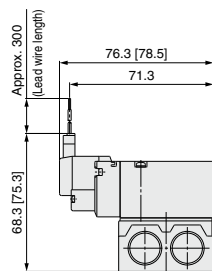

Unless otherwise indicated, dimensions are the same as Grommet (G).
[] : AC

DIN terminal (Y): VQZ3□5□-□Y□1-02⁰³

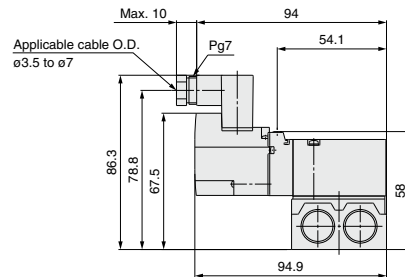

Unless otherwise indicated, dimensions are the same as Grommet (G).

Base Mounted
Plug Lead Unit

3 Port Solenoid Valve VQZ100/200/300 Series Manifold Connector Kit



[Option]
Note) For CE-compliant models, DC-type only.

VQZ100 / How to Order Manifold

VV3QZ 1 5 - 08 C6 C - [] - []

Series
1 VQZ100

Manifold type
5 Base mounted

Stations
02 2 stations
: :
20 20 stations

Port size [2(A) port]

C3	ø3.2 One-touch fitting	For side ported
C4	ø4 One-touch fitting	
C6	ø6 One-touch fitting	
M5	M5 thread (Replaceable type)	For top ported
CP <small>Note 1)</small>	With port plug	
CM <small>Note 2)</small>	Mixed port sizes	

CE-compliant
Nil —
Q CE-compliant

Option

Nil	None
D	DIN rail mounting (With standard DIN rail length)
DO	DIN rail mounting (Without DIN rail)
R	External pilot type

Note 1) Order DIN rail separately. For DIN rail part no., refer to page 1252.
Note 2) When two or more symbols are specified, indicate them alphabetically.

Kit type
C Connector

Note 1) When CP port plug is attached on all 2(A) port. Valve on manifold is top ported.
Note 2) Specify the mixture port (including top and side piping) by the manifold specification sheet.
Note 3) For inch size One-touch fittings, refer to page 1253.

VQZ100 / How to Order Valve

VQZ 1 1 5 [] - 5 M [] 1 - C4 - []

Series
1 VQZ100 body width 10 mm

Type of actuation
1 N.C.

Body type
5 Base mounded

Function

Symbol	Specifications	DC	AC
Nil	Standard	○ <small>(0.35 W) Note 3)</small>	○
K	High pressure type	○ <small>(0.9 W)</small>	—
R	External pilot type	○	○
KR	High pressure/External pilot type	○ <small>(0.9 W)</small>	—

Note 1) Semi-standard
Note 2) For details on external pilot type, refer to page 1253.
Note 3) For AC specification power consumption, refer to page 1240.

CE-compliant
Nil —
Q CE-compliant
Note) For CE-compliant models, DC type only.

Port size

CP	With port plug	For side ported
C3	ø3.2 One-touch fitting	For top ported
C4	ø4 One-touch fitting	
C6	ø6 One-touch fitting	
M5	M5 thread	

Note) For inch size One-touch fittings, refer to page 1253.

Manual override

Nil	Non-locking push type (Tool required)
B	Locking type (Tool required)

Coil voltage

	CE-compliant
1 100 VAC (50/60 Hz)	—
2 200 VAC (50/60 Hz)	—
3 110 VAC [115 VAC] (50/60 Hz)	—
4 220 VAC [230 VAC] (50/60 Hz)	—
5 24 VDC	●
6 12 VDC	●

Electrical entry

Symbol	Electrical entry	Light/surge voltage suppressor
G	Grommet (DC specification)	None
L	L-plug plug connector with lead wire	Yes
LO	L-plug plug connector without connector	
M	M-plug plug connector with lead wire	
MO	M-plug plug connector without connector	

Note) Standard lead wire length: 300 mm
Note) When ordering single unit of the base mounted type solenoid valve, the mounting screws and gaskets for the manifold are included.

Caution
Use standard (DC) specification for continuous duty.

SYJ
VQZ
VP
VG
VP3



Base Mounted **VQZ100/200/300 Series**

Manifold Specifications

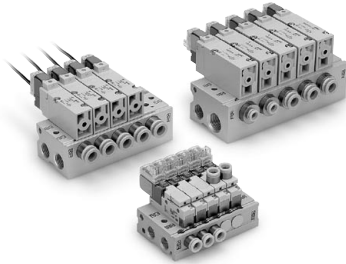

Series	Base model	Piping specifications			Applicable solenoid valve	Applicable stations	Manifold base weight (g) ^{Note)}
		Piping direction	Port size				
			1(P), 3(R)	2(A)			
VQZ100	VV3QZ15-□□□	Side/Top	Rc 1/8	C3 (for ø3.2) C4 (for ø4) C6 (for ø6) M5 (M5 thread)	VQZ115	2 to 20 stations	2 stations: 83 Addition per station: 19
VQZ200	VV3QZ25-□□□	Side	Rc 1/4	C4 (for ø4) C6 (for ø6) C8 (for ø8) Rc 1/8	VQZ2□5	2 to 20 stations	2 stations: 126 Addition per station: 38
VQZ300	VV3QZ35-□□□	Side	1(P) port Rc 3/8 3(R) port Rc 1/4	C6 (for ø6) C8 (for ø8) C10 (for ø10) Rc 1/4	VQZ3□5	2 to 20 stations	2 stations: 209 Addition per station: 60

Note) Weight for threaded connection.

How to Order Manifold Assembly (Example)

VV3QZ25-05C6C 1 set (C kit 5-station manifold base part no.)
 VVQZ200-10A-5 1 set (Blanking plate assembly part no.)
 VQZ215-5L1 4 sets (N.C. type part no.)

The asterisk denotes the symbol for assembly.
 Prefix it to the part nos. of the solenoid valve, etc.

Enter in order starting from the first station on the D side.

Add the valve and option part number under the manifold base part number.
 When entry of part numbers becomes complicated, indicate by the manifold specification sheet.

SYJ

VQZ

VP

VG

VP3

VQZ100/200/300 Series

Dimensions: VQZ100: Top Ported

VV3QZ15- Stations Port size C

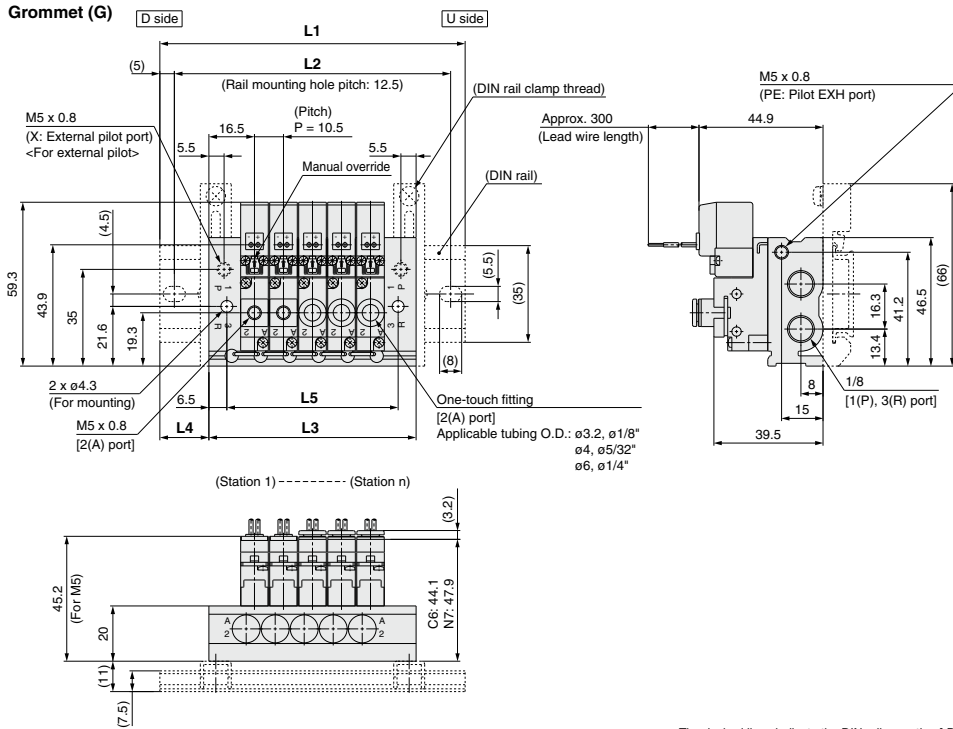

The dashed lines indicate the DIN rail mounting [-D].

M5

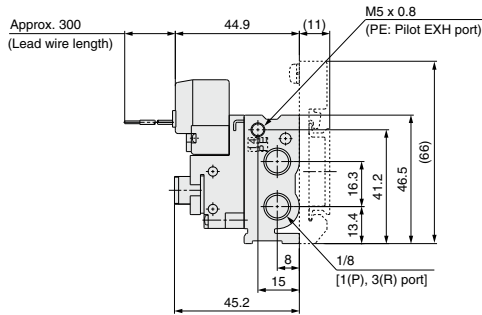

Dimensions

n: Stations (Max. 20 stations)

n	2	3	4	5	6	7	8	9	10	11	12	13	14	15	16	17	18	19	20
L1	85.5	85.5	98	110.5	123	135.5	148	148	160.5	173	185.5	198	210.5	210.5	223	235.5	248	260.5	273
L2	75	75	87.5	100	112.5	125	137.5	137.5	150	162.5	175	187.5	200	200	212.5	225	237.5	250	262.5
L3	43.5	54	64.5	75	85.5	96	106.5	117	127.5	138	148.5	159	169.5	180	190.5	201	211.5	222	232.5
L4	21	16	17	18	19	20	21	15.5	16.5	17.5	18.5	19.5	20.5	15.5	16.5	17.5	18.5	19.5	20.5
L5	30.5	41	51.5	62	72.5	83	93.5	104	114.5	125	135.5	146	156.5	167	177.5	188	198.5	209	219.5

Base Mounted VQZ100/200/300 Series

Dimensions: VQZ100: Side Ported

VV3QZ15- [Stations] [Port size] C

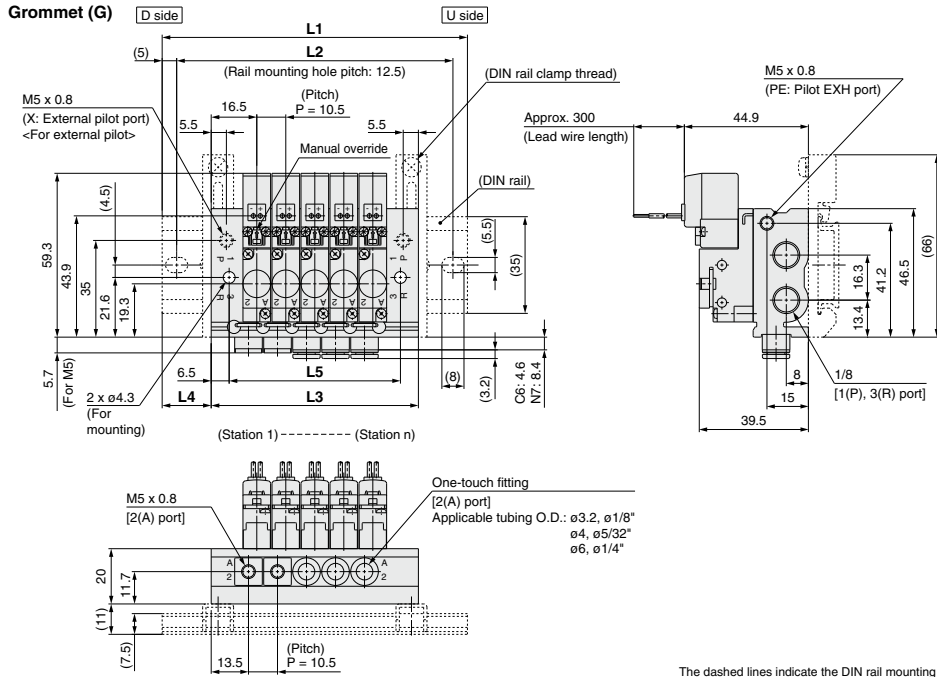

L-type plug connector (L)

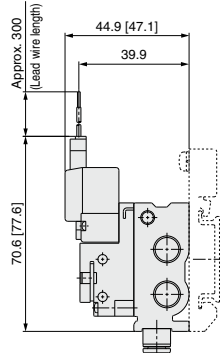

Unless otherwise indicated, dimensions are the same as Grommet (G).
[]: AC

M-type plug connector (M)

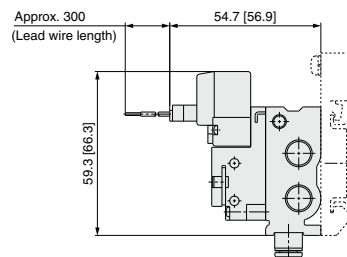

Unless otherwise indicated, dimensions are the same as Grommet (G).
[]: AC

Dimensions

n: Stations (Max. 20 stations)

L	n	2	3	4	5	6	7	8	9	10	11	12	13	14	15	16	17	18	19	20
L1		85.5	85.5	98	110.5	123	135.5	148	148	160.5	173	185.5	198	210.5	210.5	223	235.5	248	260.5	273
L2		75	75	87.5	100	112.5	125	137.5	137.5	150	162.5	175	187.5	200	200	212.5	225	237.5	250	262.5
L3		43.5	54	64.5	75	85.5	96	106.5	117	127.5	138	148.5	159	169.5	180	190.5	201	211.5	222	232.5
L4		21	16	17	18	19	20	21	15.5	16.5	17.5	18.5	19.5	20.5	15.5	16.5	17.5	18.5	19.5	20.5
L5		30.5	41	51.5	62	72.5	83	93.5	104	114.5	125	135.5	146	156.5	167	177.5	188	198.5	209	219.5



SYJ
VQZ
VP
VG
VP3

VQZ100/200/300 Series

Dimensions: VQZ200

VV3QZ25- [Stations] Port size C

Grommet (G)

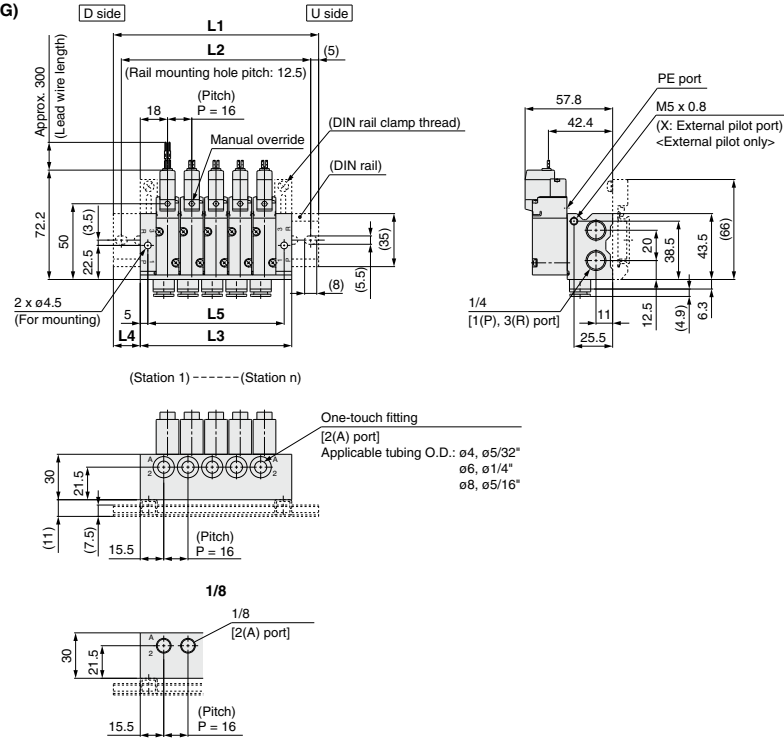

The dashed lines indicate the DIN rail mounting [-D].

L-type plug connector (L)

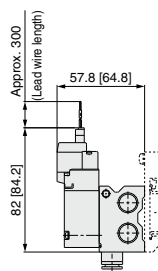

Unless otherwise indicated, dimensions are the same as Grommet (G).
[] : AC

M-type plug connector (M)

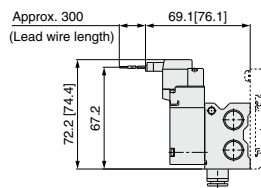

Unless otherwise indicated, dimensions are the same as Grommet (G).
[] : AC

DIN terminal (Y)

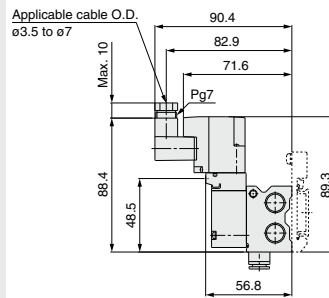

Unless otherwise indicated, dimensions are the same as Grommet (G).

Dimensions

n: Stations (Max. 20 stations)

n	2	3	4	5	6	7	8	9	10	11	12	13	14	15	16	17	18	19	20
L1	85.5	98	123	135.5	148	173	185.5	198	210.5	235.5	248	260.5	285.5	298	310.5	323	348	360.5	373
L2	75	87.5	112.5	125	137.5	162.5	175	187.5	200	225	237.5	250	275	287.5	300	312.5	337.5	350	362.5
L3	52	68	84	100	116	132	148	164	180	196	212	228	244	260	276	292	308	324	340
L4	17	15	19.5	18	16	20.5	19	17	15.5	20	18	16.5	21	19	17.5	15.5	20	18.5	16.5
L5	42	58	74	90	106	122	138	154	170	186	202	218	234	250	266	282	298	314	330

Base Mounted VQZ100/200/300 Series

Dimensions: VQZ300

VV3QZ35- [Stations] Port size C

Grommet (G)

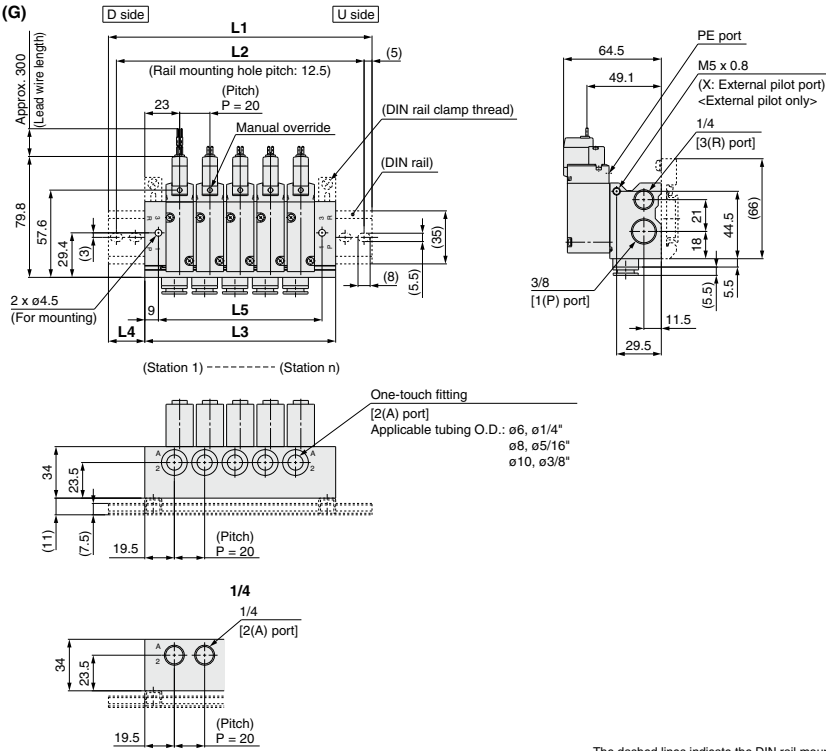

The dashed lines indicate the DIN rail mounting [-D].

L-type plug connector (L)

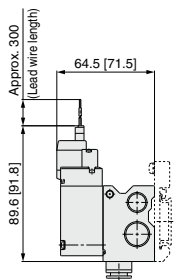

Unless otherwise indicated, dimensions are the same as Grommet (G).
[] : AC

M-type plug connector (M)

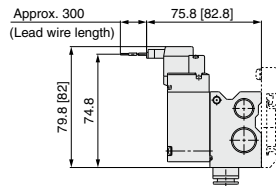

Unless otherwise indicated, dimensions are the same as Grommet (G).
[] : AC

DIN terminal (Y)

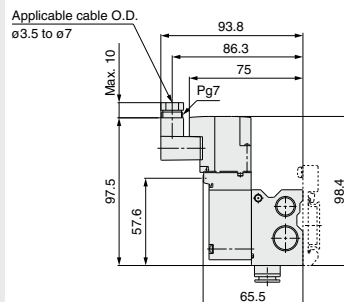

Unless otherwise indicated, dimensions are the same as Grommet (G).

SYJ

VQZ

VP

VG

VP3

Dimensions

n	2	3	4	5	6	7	8	9	10	11	12	13	14	15	16	17	18	19	20
L1	98	123	148	160.5	185.5	198	223	248	260.5	285.5	298	323	348	360.5	385.5	398	423	448	460.5
L2	87.5	112.5	137.5	150	175	187.5	212.5	237.5	250	275	287.5	312.5	337.5	350	375	387.5	412.5	437.5	450
L3	66	86	106	126	146	166	186	206	226	246	266	286	306	326	346	366	386	406	426
L4	16	18.5	21	17.5	20	16	18.5	21	17.5	20	16	18.5	21	17.5	20	16	18.5	21	17.5
L5	48	68	88	108	128	148	168	188	208	228	248	268	288	308	328	348	368	388	408

n: Stations (Max. 20 stations)

VQZ100/200/300 Series

Manifold Options

Blanking plate assembly

VVQZ100-10A-5 (for VQZ100)

VVQZ200-10A-5 (for VQZ200)

VVQZ300-10A-5 (for VQZ300)

It is used by attaching on the manifold block for being prepared for removing a valve for maintenance reasons or planning to mount a spare valve, etc.

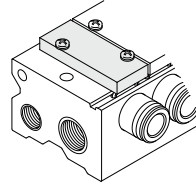

Blanking plug

KQ2P-23

KQ2P-04

KQ2P-06

KQ2P-08

KQ2P-10

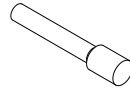
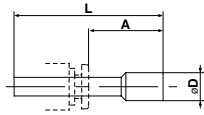

Dimensions

(mm)

Applicable fitting size ød	Model	A	L	D
3.2	KQ2P-23	16	31.5	5
4	KQ2P-04	16	32	6
6	KQ2P-06	18	35	8
8	KQ2P-08	20.5	39	10
10	KQ2P-10	22	43	12

DIN rail

AXT100-DR-□

* As for □, enter the number from the DIN rail dimensions table. For L dimension, refer to the dimensions of each kit.

Each manifold can be mounted on a DIN rail. Insert "D" at the end of the manifold part number. The DIN rail is approximately 30 mm longer than the length of manifold.

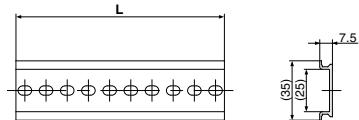

L Dimension

No.	1	2	3	4	5	6	7	8	9	10	11	12	13	14	15	16	17	18	19	20
L dimension	23	35.5	48	60.5	73	85.5	98	110.5	123	135.5	148	160.5	173	185.5	198	210.5	223	235.5	248	260.5
No.	21	22	23	24	25	26	27	28	29	30	31	32	33	34	35	36	37	38	39	40
L dimension	273	285.5	298	310.5	323	335.5	348	360.5	373	385.5	398	410.5	423	435.5	448	460.5	473	485.5	498	510.5

Silencer

(for manifold EXH port)

Silencer is installed in the manifold EXH port.

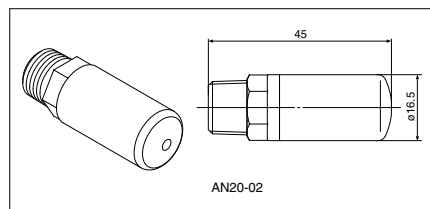
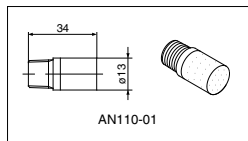

Dimensions

Model	Silencer part no.
VQZ100	AN110-01
VQZ200	AN20-02
VQZ300	AN20-02

Port plug

VVQZ100-CP (for VQZ100)

This is used when changing piping location. (Side or Top)



VQZ Series Base Mounted

Semi-standard Specifications €

[Option]

External Pilot Specification

The external pilot specification is used when the operating pressure is below the minimum operating pressure 0.1 to 0.15 MPa or when valve is used for a vacuum application. Order a valve by adding the external pilot specification [R] to the part number.

Valve Part No.

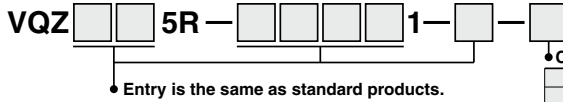

• CE-compliant

Nil	—
Q	CE-compliant

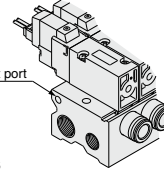

Manifold Part No.

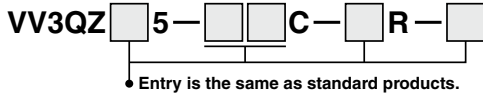

Pressure Specifications

Series		VQZ100 ^{Note 2)}	VQZ200/300
External pilot pressure range ^{Note 1)}	Metal seal	—	0.1 to 0.7 MPa
	Rubber seal (VQZ100: poppet)	0.2 to 0.7 MPa	0.15 to 0.7 MPa
Operating pressure range ^{Note 1)}		-100 kPa to 0.7 MPa	

Note 1) In case of the high pressure type, upper limit of max. operating pressure and external pilot pressure range is 1 MPa.

Note 2) When using the VQZ100 series for a vacuum application, vacuum air through its 1(P) port. When supplying vacuum-release air, supply it through its 3(R) port. But do not supply vacuum-release air exceeding 50% for the external pilot pressure.

In addition, when the VQZ100 is to be used at an operating pressure greater than 0.2 MPa, please assure that the operating pressure is set to equal to or less than the external pilot pressure.

Inch Size One-touch Fittings and Optional Threads

Inch size One-touch fittings and NPT, NPTF and G thread are available.

Manifold Part No.

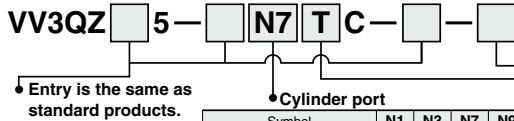

• CE-compliant

Nil	—
Q	CE-compliant

Symbol	N1	N3	N7	N9	N11	NM ^{Note 1)}	M5	01	02
Applicable tubing O.D.	ø1/8"	ø5/32"	ø1/4"	ø5/16"	ø3/8"	Mixed	M5 thread	1/8 thread	1/4 thread
Cylinder port	VQZ100	●	●	●	—	●	●	—	—
	VQZ200	—	—	●	●	●	—	—	—
	VQZ300	—	—	●	●	●	—	—	●

Nil	Rc
N	NPT
T	NPTF
F	G

SYJ

VQZ

VP

VG

VP3

Note 1) Except VQZ100, mixing One-touch fittings and thread types is impossible.
Note 2) Metric size One-touch fittings (C□) are also available.

Optional Threads Other than Rc

Rc specifications are standard for all ports, however, NPT, NPTF and G are available for overseas markets. Add the appropriate symbol following the port size in the standard part number.

Valve Part No.

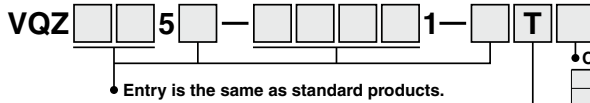

• CE-compliant

Nil	—
Q	CE-compliant

• Thread type (Cylinder port and 1(P), 3(R) ports of sub-plate)

Nil	Rc
N	NPT
T	NPTF
F	G

IP65 Enclosure (Based on IEC60529)

DIN terminal is available with IP65 enclosure.

Valve Part No.

(Applicable to the VQZ200/300 rubber seal with the exception of the external pilot type)

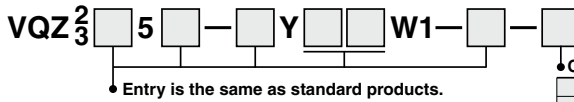

• CE-compliant

Nil	—
Q	CE-compliant

Note) The pilot exhaust IP65 valves is common with main valve exhaust. (The standard valve has an individual exhaust for the pilot valve.)



VQZ Series Base Mounted

Replacement Parts

One-touch Fitting Assembly (for Cylinder port)

Model	Fitting size	C3	C4	C6	C8	C10	M5 (VQZ100 only)
VQZ100		VVQ1000-50A-C3	VVQ1000-50A-C4	VVQ1000-50A-C6	—	—	VVQ1000-50A-M5
VQZ200		—	VVQ1000-51A-C4	VVQ1000-51A-C6	VVQ1000-51A-C8	—	—
VQZ300		—	—	VVQ2000-51A-C6	VVQ2000-51A-C8	VVQ2000-51A-C10	—

Note) Purchasing order is available in units of 10 pieces.

<Plug connector assembly>

- DC: SY100-30-4A-□
- 100 VAC: SY100-30-1A-□
- 200 VAC: SY100-30-2A-□
- Other AC voltages: SY100-30-3A-□
- Without lead wire: SY100-30-A (with connector and 2 sockets only)

Lead wire length

Nil	300 mm
6	600 mm
10	1000 mm
15	1500 mm
20	2000 mm
25	2500 mm
30	3000 mm
50	5000 mm

How to Order

Include the connector assembly part number together with the part number for the plug connector's solenoid valve without connector.

Example) In case of 2000 mm of lead wire

DC	AC
VQZ115-5L01-M5	VQZ115-1L01-M5
SY100-30-4A-20	SY100-30-1A-20

<Gasket and screw assembly>

Model	Part no.
VQZ100	VQZ100-GS-5
VQZ200	VQZ200-GS-5
VQZ300	VQZ300-GS-5

Note) The above part numbers are for 10 valves (a set of 10 gaskets and 20 screws).



<Sub-plate>

Model	Sub-plate part no.	
	For internal pilot	For external pilot
VQZ100	VQZ100-S-01□(-Q)	VQZ100-S-01□(-R(-Q))
VQZ200	VQZ200-S-01□(-Q)	VQZ200-S-01□(-R(-Q))
VQZ300	VQZ300-S-01□(-Q)	VQZ300-S-01□(-R(-Q))

* Thread type

<Pilot valve assembly>

V111 □ □ — 5 G □

Function

Symbol	Specifications	DC (0.35 W)	AC
Nil	Standard	○	○
B (Note)	High speed response type (Applicable to VQZ200/300)	○	—
K (Note)	High pressure type (Applicable to Metal seal type, Poppet seal type)	○	—

Note) Semi-standard

Manual override

Nil	None (Applicable to VQZ200/300)
M	Yes (Applicable to VQZ100)

Manual override (Applicable to the VQZ100)

Nil	Non-locking push type
B	Locking slotted type

Coil voltage

1	100 VAC (50/60 Hz)
2	200 VAC (50/60 Hz)
3	110 VAC (50/60 Hz)
4	220 VAC (50/60 Hz)
5	24 VDC
6	12 VDC

Electrical entry

Symbol	Electrical entry	Light/surge voltage suppressor
DC	AC	
G	— Grommet (DC specification)	None
LU	LZ	L-type plug connector with lead wire
LOU	LOZ	L-type plug connector without connector
MU	MZ	M-type plug connector with lead wire
MOU	MOZ	M-type plug connector without connector

Note) The electrical entry (L, M) for the VQZ100 pilot valve is different from that of the main valve model number.

<DIN terminal type (Applicable to the VQZ200/300)>

V115 □ □ — 5 Y — X110

Function

Symbol	Specifications	DC (0.35 W)	AC
Nil	Standard	○	○
B (Note)	High speed response type	○	—
K (Note)	High pressure type (Metal seal type only)	○	—

Note) Semi-standard

Coil voltage

1	100 VAC (50/60 Hz)
2	200 VAC (50/60 Hz)
3	110 VAC (50/60 Hz)
4	220 VAC (50/60 Hz)
5	24 VDC
6	12 VDC

Electrical entry

Symbol	Electrical entry	Light/surge voltage suppressor
Y	DIN terminal	None
YO	DIN terminal without connector	
YZ	DIN terminal with light/surge voltage suppressor	Yes
YS (Note)	DIN terminal with surge voltage suppressor (DC specification)	Yes
YOS (Note)	DIN terminal with surge voltage suppressor, without connector (DC specification)	Yes (Without light)

Note) For AC voltage valves there is no "S" option. It is already built-in to the rectifier circuit.

⚠ Caution

When replacing only the pilot valve assembly, use caution because it is not possible to convert to a V115 (DIN terminal) from a V111 (Grommet, L-type, M-type), or vice versa.

VQZ200/300 Series Made to Order

Please contact SMC for detailed dimensions, specifications and lead times.



1 Pilot Valve Common Exhaust Specification

Pilot exhaust is exhausted through the main R port.

- * Not designed to prevent leakage to outside.
- * A combination of external pilots is not available.
- * "How to Order Manifold" is the same as standard products. Please specify this to "How to Order Valve."

Applicable solenoid valve series: VQZ200/300

How to Order

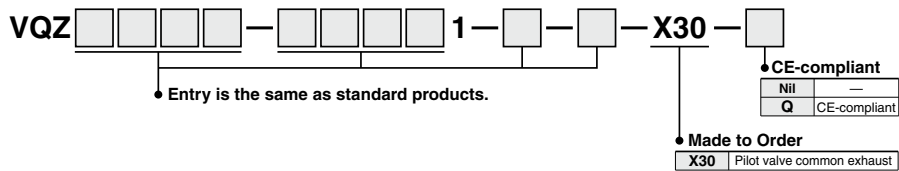

2 Main Valve Fluororubber Specification

The seal material, the part of the main valve in contact with fluid, is made of fluororubber.

- * "How to Order Manifold" is the same as standard products. Please specify this to "How to Order Valve."

Applicable solenoid valve series: VQZ200/300

How to Order

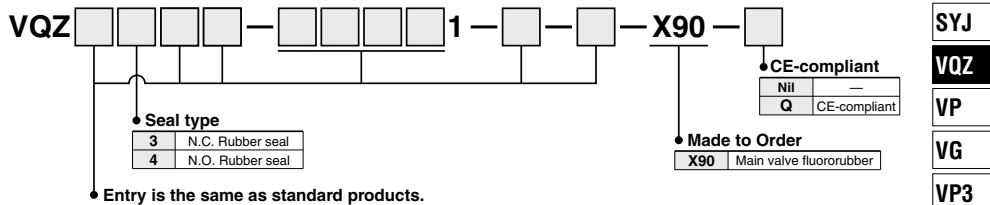

3 All Fluororubber Specification

The rubber material of the part in contact with fluid, is made of fluororubber.

- * "How to Order Manifold" is the same as standard products. Please specify this to "How to Order Valve."

Applicable solenoid valve series: VQZ200/300

How to Order

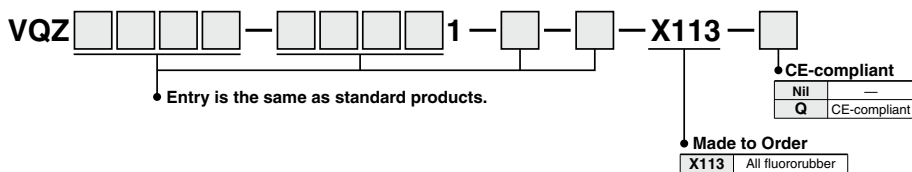



VQZ Series Specific Product Precautions 1

Be sure to read this before handling the products.
Refer to back page 50 for Safety Instructions and pages 3 to 9 for 3/4/5 Port Solenoid Valve Precautions.

Manual Override

⚠ Caution

Without an electric signal for the solenoid valve the manual override is used for switching the main valve. Push type is standard. Locking type (Tool required) is available as an option.

1. VQZ100

Push type

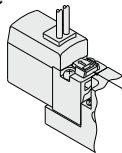

Press in the direction of the arrow.

Locking type (Tool required)

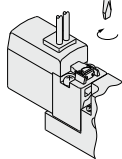

Turn 90° in the direction of arrow.

2. VQZ200/300

Push type (Tool required)

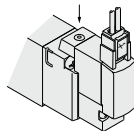

Push down on the manual override button with a small screwdriver until it stops. Release the screwdriver and the manual override will return.

Locking type (Tool required)

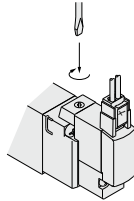

Push down completely on the manual override button with a small screwdriver. While down, turn clockwise 90° to lock it. Turn it counterclockwise to release it.

Locked position

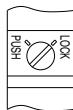

Precautions

When operating with a screwdriver, turn it gently using a watchmaker's screwdriver. (Torque: less than 0.1 N·m)
Press and rotate to lock the manual operation of VQZ200/300. If rotate without pressing, manual breakage and air leakage could be occurred.

How to Use L/M-Type Plug Connector

⚠ Caution

1. Attaching and detaching connectors

To attach a connector, hold the lever and connector unit between your fingers and insert straight onto the pins of the solenoid valve and remove the pawl from the groove by pushing the lever downward with your thumb, and pull the connector straight out.

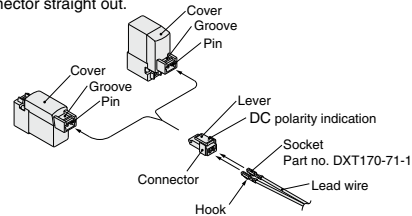

Light/Surge Voltage Suppressor

⚠ Caution

1. L/M-type plug connector

<DC>

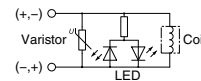

<AC>

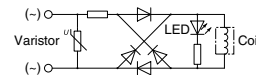

2. DIN terminal

<DC>

With surge voltage suppressor (YS, YOS)

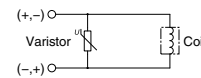

Light/surge voltage suppressor (YZ)

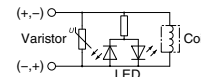

<AC>

With light (YZ)

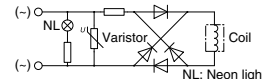

Note) Surge voltage suppressor of varistor has residual voltage corresponding to the protective element and rated voltage; therefore, protect the controller side from the surge.



VQZ Series Specific Product Precautions 2

Be sure to read this before handling the products.

Refer to back page 50 for Safety Instructions and pages 3 to 9 for 3/4/5 Port Solenoid Valve Precautions.

Lead Wire Connection

⚠ Caution

1. Crimping of lead wires and sockets

Not necessary if ordering the lead wire pre-connected model. Strip 3.2 to 3.7 mm at the end of the lead wires, insert the ends of the core wires evenly into the sockets, and then crimp with a crimping tool. When this is done, take care that the coverings of the lead wires do not enter the core wire crimping area.

(Please contact SMC for the crimping tools.)

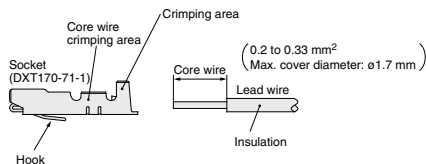

2. Attaching and detaching sockets with lead wires

Attaching

Insert the sockets into the square holes of the connector (⊕, ⊖ indication), and continue to push the sockets all the way in until they lock by hooking into the seats in the connector. (When they are pushed in, their hooks open and they are locked automatically.) Then, confirm that they are locked by pulling lightly on the lead wires.

Detaching

To detach a socket from a connector, pull out the lead wire while pressing the socket's hook with a stick having a thin tip (approx. 1 mm). If the socket will be used again, first spread the hook outward.

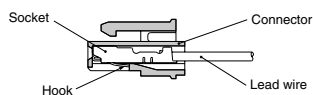

Pilot Valve Replacement

⚠ Caution

1. When replacing a current type valve with a new type for maintenance or other reasons, a "conversion connector assembly" is necessary to convert the connector from 3 terminals to 2 terminals and must be ordered separately. (When ordering, refer to the below part nos.)

For pilot valves, there is no compatibility between the current type and new type. When replacing a pilot valve, be sure to confirm whether it is the new type or the current type.

[Current]

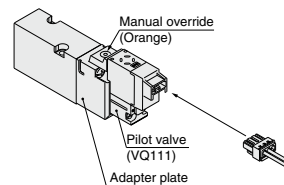

[New]

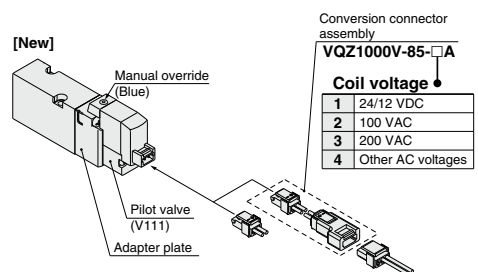

SYJ
VQZ
VP
VG
VP3



VQZ Series Specific Product Precautions 3

Be sure to read this before handling the products.
Refer to back page 50 for Safety Instructions and pages 3 to 9 for 3/4/5 Port Solenoid Valve Precautions.

How to Use DIN Terminal

1. EN-175301-803C (Former DIN 43650C) (8 mm between pins)

The DIN terminal type with an IP65 enclosure is protected against dust and water, however, it must not be used in water.

2. Connection

- Loosen the holding screw and pull the connector out of the solenoid valve terminal block.
- After removing the holding screw, insert a flat head screwdriver, etc. into the notch on the bottom of the terminal block and pry it open, separating the terminal block and the housing.
- Loosen the terminal screws (slotted screws) on the terminal block, insert the cores of the lead wires into the terminals according to the connection method, and fasten them securely with the terminal screws.
- Secure the cord by fastening the ground nut.

3. Changing the entry direction

After separating the terminal block and housing, the cord entry can be changed by attaching the housing in the desired direction (4 directions at 90° intervals).

* When equipped with a light, be careful not to damage the light with the cord's lead wires.

4. Precautions

Plug in and pull out the connector vertically without tilting to one side.

5. Compatible cable

Cable O.D.: $\phi 3.5$ to $\phi 7$
(Reference) 0.5 mm^2 , 2-core or 3-core, equivalent to JIS C 3306

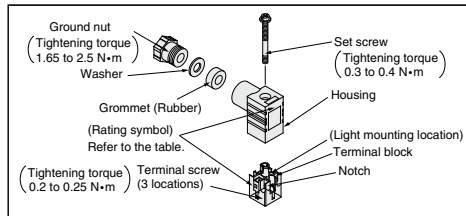

DIN Connector Part No.

Without light

Rated voltage	Voltage symbol	Part no.
All voltages	None	SY100-82-1

With light

Rated voltage	Voltage symbol	Part no.
24 VDC	24 V	SY100-82-3-05
12 VDC	12 V	SY100-82-3-06
100 VAC	100 V	SY100-82-2-01
200 VAC	200 V	SY100-82-2-02
110 VAC (115 VAC)	110 V	SY100-82-2-03
220 VAC (230 VAC)	220 V	SY100-82-2-04

Circuit diagram with light

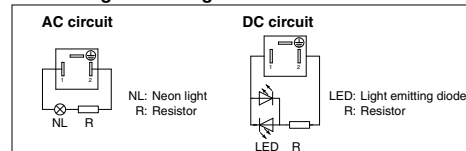

Fitting and Silencer Part No. for P, R Ports When Using Valve as an Individual Unit

Part no. for one-touch fitting for 1(P) port and silencer/one-touch fitting for 3(R) port

Series	(1) One-touch fitting for 1(P) port	(2) For 3(R) port	
		Silencer	One-touch fitting
VQZ100	KQ2H06-M5A	AN120-M5	KJS04-M5A
VQZ200	KQ2S06-01AS	INA-25-46	IN-457-32L (for $\phi 6$)
VQZ300	KQ2H08-02AS	AN101-01	KQ2H06-01AS

The diameter of the above fitting and silencer is the maximum diameter to in the EXH port.

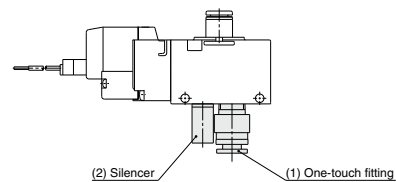



VQZ Series Specific Product Precautions 4

Be sure to read this before handling the products.
Refer to back page 50 for Safety Instructions and pages 3 to 9 for 3/4/5 Port Solenoid Valve Precautions.

One-touch Fittings Replacement

⚠ Caution

The built-in fittings on the manifold can be changed easily. Simply remove the corresponding valve and take out the fitting clip underneath.

Take out the clip with a screwdriver, etc., then replace the fittings. About mounting the fittings, after inserting the fitting until it stops, then put the clip into the prescribed position.

VQZ200: Horizontally clipped to the valve body
VQZ100/300: Vertically clipped to the valve body

■ Valve

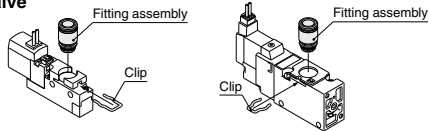

Valve Clip Part No. (10 pcs. included)

Series	Part number
VQZ100	VQZ100-2-FC
VQZ200	VQZ200-2-FC
VQZ300	VQZ300-2-FC

■ Manifold base

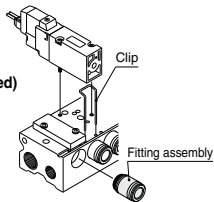

Base Clip Part No. (10 pcs. included)

Series	Part number
VV3QZ15	VQZ100-5-FC
VV3QZ25	VQZ200-5-FC
VV3QZ35	VQZ300-5-FC

Precautions

When pulling the fitting assembly away from the valve base, remove the clip, then connect a tube or plug (KQ2P-□□) with the One-touch fitting and pull it out holding the tube or plug. Do not hold the release bushing to avoid damage.

DIN Rail Removal/Mounting

⚠ Caution

1. Removing

- Loosen the clamp screw on the (a) side of both ends of the manifold.
- Lift the (a) side of the manifold off the DIN rail and slide it in the direction of the (b) side.

2. Mounting

- Catch the hook of the DIN rail bracket on the (b) side on the DIN rail.
- Push side (a) onto the DIN rail and tighten the clamp screw. The proper tightening torque for screws is 0.3 to 0.4 N·m.

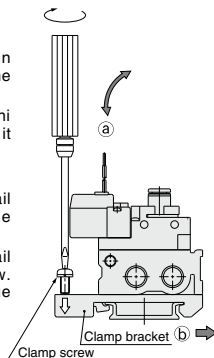

Valve Mounting

⚠ Caution

- After confirming the gasket is correctly placed under the valve, securely tighten the bolts with the proper torque shown in the table below.

Model	Proper tightening torque
VQZ100	0.13 to 0.19 N·m
VQZ200	0.25 to 0.35 N·m
VQZ300	0.5 to 0.7 N·m

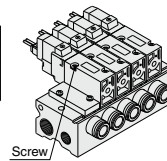

VQZ100 Piping Direction Replacement

⚠ Caution

- How to replace the port direction

Fitting and port plug are modules. After removing the clip with a flat head screwdriver, take out the fitting and port plug. The piping direction (side or top) can be altered by exchanging the fitting and port plug. During exchange, insert the fitting and the port plug until they contact the wall, then, insert the clip to specified position.

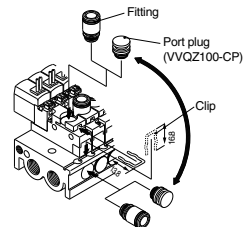

Precautions

The clip length for the valve and the base are different. Fitting may detach if the incorrect clip is used.

- Valve piped on top can be operated independently by using PR plate.

(Refer to the below part numbers when placing an order.)

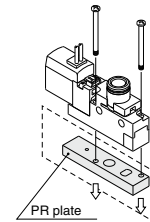

VQZ100-12A (Standard)
VQZ100-12B (External pilot type)
* 2 set screws are included.

SYJ
VQZ
VP
VG
VP3