

Дроссель/пневмоглушитель

ASN2

M5 ~ R1/2

- Шумопоглощение более 20 dB при максимальной величине расхода.
- Простой контроль скорости цилиндра.
- Специальный стопор предотвращает случайную потерю регулирующей иглы.



Технические характеристики

Испытательное давление (МПа)	1,5
Диапазон рабочих давлений (МПа)	0 ~ 1
Диапазон рабочих температур (°C)	-5 ~ 60
Диапазон регулирования (число оборотов вращения иглы)	10 (8 для ASN2-M5)

Характеристики расхода

Давление на входе 0,5 МПа

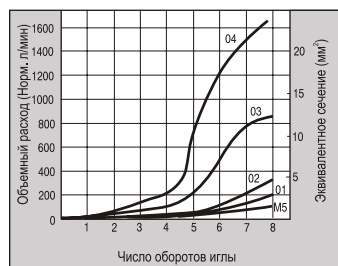

Размеры и данные по заказу

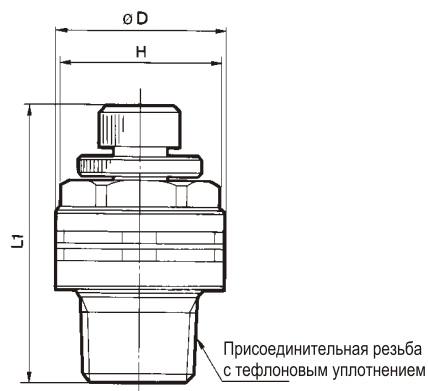

Номер для заказа	Присоединительная резьба	ø D	L1		H (размер под ключ)	Вес (г)
			Мин.	Макс.		
ASN2-M5	M5x0,8	10	20,5	23,3	8	5
ASN2-01-S	R1/8	15	30	35	12 (12,7)	17
ASN2-02-S	R1/4	20	34,2	39,2	17 (17,5)	34
ASN2-03-S	R3/8	25	37	42	19	55
ASN2-04-S	R1/2	30	49	54	24 (23,8)	107

Metering Valve with Silencer

ASN2 Series



Superior sound reducing performance

Over 20 dB at max. flow rate

Cylinder speed easily set

Shape of needle is the same as that of speed controller

Retainer prevents accidental loss of needle



Symbol



<Example of mounting>

Metering Valve with Silencer

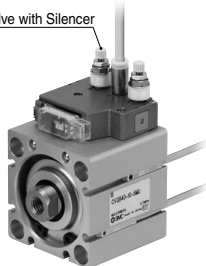

Model

Model	Port size	Sonic conductance dm ³ /(s.bar)	Critical pressure ratio	Weight (g)
ASN2-M5	M5 x 0.8	0.36	0.15	5
ASN2-U10/32	10-32 UNF	0.36		5
ASN2-01	1/8	0.72	0.35	17
ASN2-02	1/4	1.3		34
ASN2-03	3/8	3.32		55
ASN2-04	1/2	4.9		107

Specifications

Proof pressure	1.5 MPa
Operating pressure range	0 to 1 MPa
Ambient and fluid temperature	- 5 to 60°C (No freezing)

How to Order

ASN2 - [] 03 - [] - []

Thread type

Nil	Metric thread (M5)
	Unified thread (10-32 UNF)
N	R
	NPT

Lock nut option

Nil	Hexagon lock nut
J	Round lock nut

Option Note)

Nil	None
S	With seal

Note) M5 and U10/32 are not available with seals.

Port size

M5	M5 x 0.8
U10/32	10-32 UNF
01	1/8
02	1/4
03	3/8
04	1/2

Needle Valve/ Flow Rate Characteristics

Note) The flow rate characteristics are representative values.

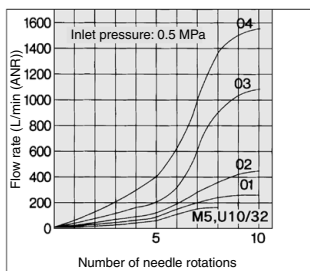

Construction

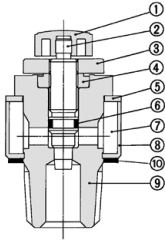

Component Parts

No.	Description	Material	Note
1	Handle	PBT	
2	Needle	Brass	Electroless nickel plated
3	Lock nut	Steel ⁽²⁾	Zinc chromated ⁽¹⁾
4	Needle guide	Brass	Electroless nickel plated
5	Washer	Carbon steel	Nickel plated
6	O-ring	NBR	
7	Silencer	PVA sponge	
8	Silencer cover	Soft polyethylene	
9	Body B	Brass	Electroless nickel plated
10	Gasket	NBR/Stainless steel	M5, U10/32 only

Note 1) The round lock nut is electroless nickel plated.

Note 2) The round lock nut is made of brass. However, note that only the ASN2-□01 and □02 use steel.

Dimensions

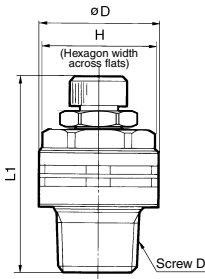

Dimensions

Model	Screw D	øD	L1 ⁽²⁾		H
			Min.	Max.	
ASN2-M5	M5 x 0.8	10	20.5	23.3	8
ASN2-U10/32	10-32 UNF	10	20.5	23.3	8
ASN2-01	1/8	15	29.1	34.1	12 (12.7)
ASN2-02	1/4	20	33.7	38.7	17 (17.5)
ASN2-03	3/8	25	35.9	40.9	19
ASN2-04	1/2	30	48.1	53.1	24 (23.8)

Note 1) (in parentheses) are the dimensions of "NPT" screw specifications.

Note 2) L1: Reference dimensions

⚠ Specific Product Precautions

Be sure to read this before handling the products.

Refer to back page 50 for Safety Instructions and pages 543 to 546 for Flow Control Equipment Precautions.

Selection

⚠ Warning

1. Example of inapplicable circuits

(a) Perfect Valve
(VF66□□, VS7-6-FPG, VS7-8-FPG)

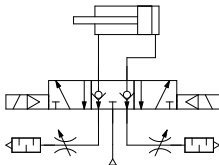

Residual pressure behind the exhaust needle may cause check valve malfunction in the Perfect Valve.

(b) Pilot check valve between Actuator and Valve

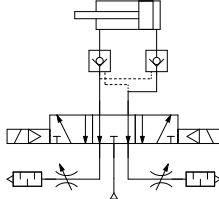

Residual pressure behind the exhaust needle may cause pilot check valve malfunction.

Installation

⚠ Warning

1. If installing flow controls to valve ports, interference may occur with the fittings. Please consult the catalog before installing.

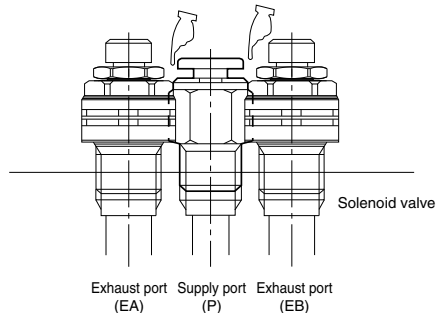

Fig. Example of the interference with fittings